

SKIPPER

EML224 / DL1 Compact Speed Log System

Operation and Installation Manual



SKIPPER Electronics AS
Enebakkeveien 150
P. O. Box 151, Manglerud
0612 Oslo, Norway
www.skipper.no

Telephone: +47 23 30 22 70
Telefax: +47 23 30 22 71
E-mail: support@skipper.no
Co. reg. no: NO-965378847-MVA

Document no: **DM-M001-SA**
Rev:0702
For software ver 1.20
Date: 2018-02-02

DL1	1 AXIS DOPPLER SPEED LOG COMPACT VERSION
EML 224	1 OR 2 AXIS ELECTROMAGNETIC SPEED LOG COMPACT VERSION

OPERATION AND INSTALLATION MANUAL

Weitergabe sowie vervielfältigung dieser unterlage, verwertung und mitteilung ihres Inhaltes nicht gestattet, soweit nicht ausdrücklich zugestanden. Zuwiderhandlungen verpflichten zu schadenersatz.

Toute communication ou reproduction de ce document, toute Exploitation ou communication de ou son contenu sont interdites, sauf autorisation expresse. Tout manquement à cette règle est illicite et expose son auteur au versement de dommages et intérêts.

Copying of this document, and giving it to others and the use or communication of contents thereof, are forbidden without express authority. Offenders are liable to the payment of damages.

Sin nuestra expresa autorización, queda terminantemente prohibida la reproducción total o parcial de este documento, así como su uso indebido y/o su exhibición o comunicación a terceros. De los infractores se exigirá el correspondiente resarcimiento de daños y perjuicios.



COMMUNICATING WITH US

If you need more information, support or other assistance from us, do not hesitate to contact us:

SKIPPER Electronics AS
P. O. Box 151, Manglerud
0612 Oslo
Norway

Phone: (+47) 23 30 22 70, Fax: (+47) 23 30 22 71
E-mail: sales@skipper.no

SOFTWARE UPDATES AND TECHNICAL SUPPORT

Find us on the internet: www.skipper.no

YOUR FEEDBACK IS APPRECIATED

If you find errors, misspellings or poorly explained sections in this document, we are happy to receive your feedback at:

support@skipper.no

OVERVIEW

CONTENT OF THE MANUAL

TERMINOLOGY

Terms, units and abbreviations used in this manual.

INTRODUCTION

This part introduces you to the Compact speed log family.

CHAPTER 1 – PHYSICAL INSTALLATION

Correct installation of the system will ensure problem free service for many years. This section explains the main steps to get your system working.

CHAPTER 2 – SETTING UP THE COMPACT DISPLAY

The Compact display is a flexible, yet intuitive display allowing data to be displayed in a user friendly way. It is also a primary system and can be integrated into the navigation system as required by the regulations. This chapter explains how to set up the unit.

CHAPTER 3 – CALIBRATION

Each new installation is unique and the system must be matched to the vessel. Calibration is required to avoid influence of mounting errors and that hydrodynamics of the vessel are compensated for. This chapter explains the procedure in a step by step guide.

CHAPTER 4 – RUNTIME OPERATION

Once the system is installed and operational, the user can change the screen to show the data of interest at any particular time. This section explains the basic operation of the system.

CHAPTER 5 – CHECKING OUT YOUR SYSTEM

It is a good idea to verify your systems performance from time to time. This chapter describes how to check interfaces and other issues. In the event of malfunction, this is a good place to start for trouble shooting.

CHAPTER 6 – MAINTENANCE

To keep your Compact speed log system in order, regular maintenance is important. To take advantages of new features and performance enhancements, you may need to update software. This section shows how.

APPENDIX 1 – BACKGROUND INFORMATION

Here you will find more details of how the system works and which factors are

important to know when using it.

APPENDIX 2 – MECHANICAL DRAWINGS

A picture is worth more than 1000 words! In addition to the text describing installation, the mechanical drawings are included to allow correct installation.

APPENDIX 3 – OUTPUT FORMATS

The system uses primarily NMEA 0183 standard. This section describes the format of the messages used. It also describes the other digital signals in use.

APPENDIX 4 - SENDING THE SYSTEM FOR REPAIR

In the unfortunate case of a failure that requires a factory repair, the return sequence described, should be followed.

APPENDIX 5 - OTHER OPTIONS WITH THE COMPACT DISPLAY

The Compact speed log can be used in a number of different systems both as a repeater and a speed log. This section explains what is available and how to activate the options. The Compact speed log also contains a diagnostics port, from which the user can obtain diagnostic information using hyperterm. This is described here.

APPENDIX 6 - SUPPORT SOFTWARE

The Compact display is alphanumeric and as such, is restricted in the amount of information it can display. SKIPPER Electronics AS is continuously developing support tools to ease use of its products. The Compact system allows for the user to extract additional information about the systems condition. This appendix describes the software tools available that will aid this process.

TABLE OF CONTENTS

Overview	4
Content of the manual	4
Terminology	9
Terms used in this manual	9
Units	9
Abbreviations	9
Introduction	11
The Compact speed log family	11
Interconnection diagram	12
Chapter 1	13
Physical installation	13
Mounting the hull metalwork	13
Mounting the sensor	14
Part positioning and welding	15
Sensor installation	15
Cabling	15
Power	16
The digital inputs and outputs	16
The pulse output	17
The dimming inputs	17
JB60CD Interconnection Diagram	18
JB60CD Connection methods	20
JB60CD-SA Connection methods	21
Speed direction (CD401EB-SB only)	22
Chapter 2	23
Setting up the Compact display	23
Principles	23
Run screens	23
Setup screens	23
Activating the runtime screens	23
Configuring of data screens	24
Setup of inputs and outputs	25
Averaging	25
Changing the baud rate	26
DL1 modes of operation	26

Demo mode	27
alarms	27
Menu diagram	28
Chapter 3	30
Calibration	30
The principles	30
Speed calibration modes	32
Checking the speed calibration	34
Water temperature offset	34
Chapter 4	35
Runtime operation	35
Runtime screens	35
Runtime diagram	36
Chapter 5	37
Checking out your system	37
Self diagnostics	37
Test points within the system	39
Logging data	39
Chapter 6	41
Maintenance	41
Routine maintenance EML	41
Routine maintenance DL1	41
Checking your version	41
Software upgrade	41
Master reset (Factory Default Settings)	42
Appendix 1	43
Background information	43
Appendix 2	45
Mechanical drawings	45
1) System overview diagram	46
2) System specifications	47
3) JB60CD Cabling diagram	50
4) JB60CD Mounting diagram	52
5) Compact display mounting diagram	53
6) Compact display connection diagram	54

Appendix 3	56
Output formats	56
Pulse outputs	56
NMEA outputs	56
NMEA inputs	57
NMEA alarm	57
Appendix 4	57
Sending the system for repair	57
Appendix 5	58
Other options with the Compact display	58
Compact display options	58
Changing the system / adding options	58
Interfacing with your display	59
Error messages	60
Appendix 6	64
Support software	64
The SKIPPER service software	64
Installation/Commisioning of the Compact speed log	65

TERMINOLOGY

TERMS USED IN THIS MANUAL

UNITS

Unless otherwise stated, all values shown on the display are as follows:

Distance	Nautical miles (nm)
Speed	Nautical miles per hour (kn)
Pulse indication	Pulses per nautical mile (p/nm)
Temperature	Degrees Celsius (°C)

ABBREVIATIONS

In addition, the following symbols are used on the runtime screens:

Tp	Daily trip (in nm)
TL	Total measured distance travelled
°	Degrees centigrade
STW	Speed through water
TRIP	Text for trip/total
SOG	Speed over ground
TEMP °	Text for TEMPerature

In menu / setup screens, the following abbreviations are used:

STWWL	Speed through water – water track – longitudinal value
STWWT	Speed through water – water track – transversal value
SOGBL	Speed over ground – bottom track – longitudinal value
SOGBT	Speed over ground – bottom track – transversal value
SOGBA	Speed over ground – bottom track – aft value
PULSE	Pulse settings
OFS °	Angular offset in degrees (°)
R	Real resultant speed at a specific point (kn)
M	Measured resultant speed at a specific point (kn)
C _{rs}	Calibrated resultant speed
M _{rs}	Instantaneous uncalibrated measured resultant speed
DIAG	Diagnostics menu

Outgoing NMEA messages follows:

VMVLW / VDVLW	\$VMVLW,....,Trip and total
VMMTW / VDMTW	\$VMMTW,....,Water temperature
VMVHW / VDVHW	\$VMVHW,....,Relative speed through water
VMVBW / VDVBW	\$VMVBW,....,Multiple speed
VMXDR / VDXDR	\$VMXDR,....,Speed direction
VMALR / VDALR	\$VMALR,....,Cause

INTRODUCTION

THE COMPACT SPEED LOG FAMILY

The SKIPPER Compact speed log family is a set of speed logs designed to have a minimal footprint on the bridge consoles, but still keeping full functionality. This manual covers two systems, built up of the same electronic units and wiring methodology, with one of two sensor technologies.

a) EML224 is a system using electromagnets to generate a current proportional to speed in the water, in one or two axis.

b) DL1 is a system using a small Doppler sensor, working in the ships axis to provide speed through water. It use acoustic signals and measures the Doppler shift of the particles in the water.

The hardware is compatible between systems (excluding sensor) while CD401 displays its version CD401XX-XB or later. However the code (code = software activation code) will be different and can be supplied from SKIPPER for retrofit.

- 1. *The mounting***; Either a sea valve or tank. Welded to the bottom of the hull with the correct orientation.
- 2. *The sensor***; A speed sensor device designed to fit into the mountings.
- 3. *The Electronic unit (JB60CD)***; The JB60CD allowing the EML 224 Compact (EML224 Compact = Compact speed log) to be powered and interfaced to the other navigation systems using digital standards.
- 4. *The CD401XX Compact display***; An alphanumeric display unit allowing the bridge staff to view the data.

The EML 224 Compact (EML224 Compact = Compact speed log) is unique in its simple, yet flexible way to display vital data in almost all conditions.

INTERCONNECTION DIAGRAM

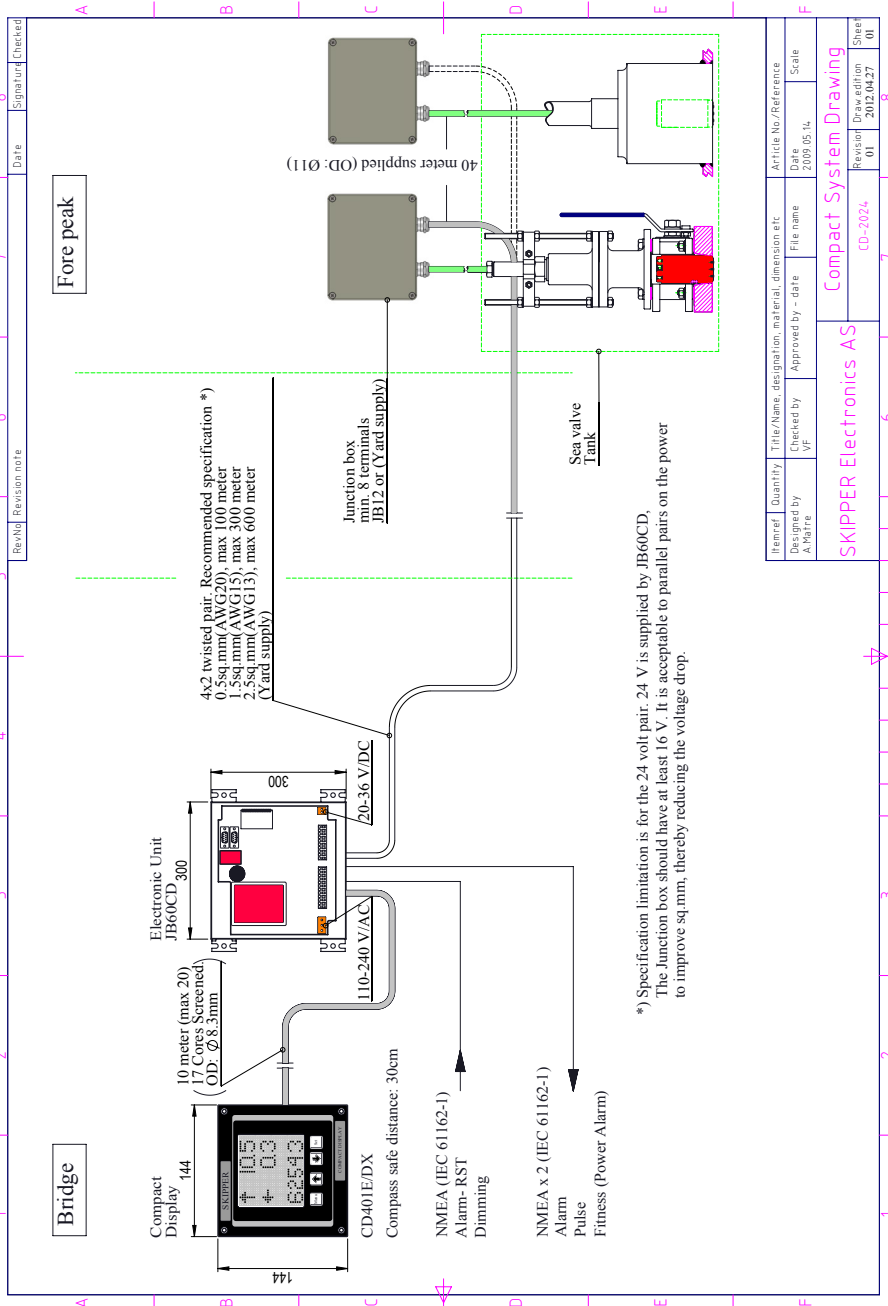

Item#	Quantity	Title/Name, designation, material, dimension, etc.	Article No./Reference
Designed by A. Møre	Checked by VF	Approved by - date	File name
2009/05/14	Scale	2012.04.27	01

Compact System Drawing

SKIPPER Electronics AS

ID-2024

Revision 01

Draw edition 01

Sheet 01

CHAPTER 1

PHYSICAL INSTALLATION

Installation usually takes place in two/three phases:

1. Mounting of the hull metalwork
2. Cabling and mounting of the electronics and sensor
3. Initialisation and calibration of the system

MOUNTING THE HULL METALWORK

This must happen in dock and care should be taken to mount the valve/tank such that the sensor will be flush with nothing to cause turbulence near the sensor. The sensor should be mounted forward in the vessel, preferably just behind the bulb.

Important: Tank mountings have an orientation (an arrow that must point forward).

The sensor is fully water tight and can be mounted in wet areas such as ballast tanks. Please see the separate mounting user guide for more details.

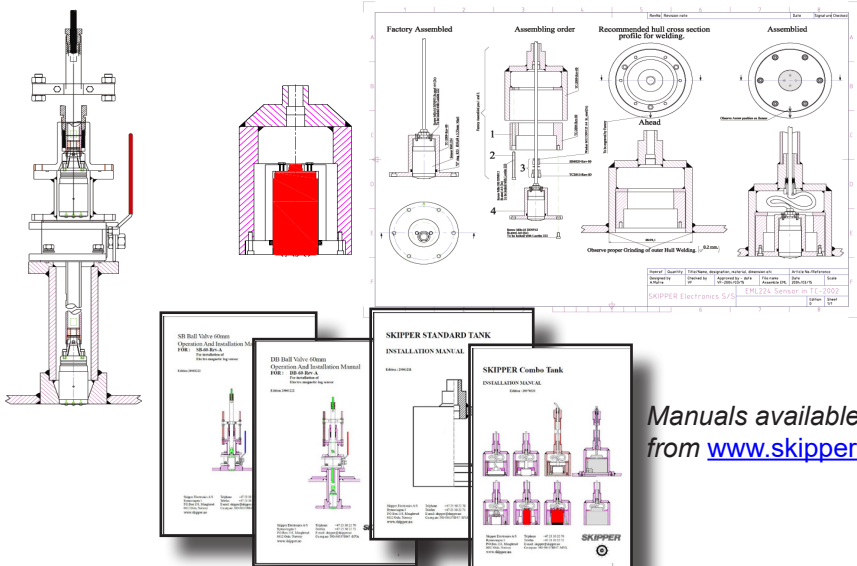

MOUNTING THE SENSOR

Sensor location.

For proper operation, the sensor should be installed close to the bulb or the bow of the ship, avoiding areas where it may be damaged by the anchor chain. It is, of course, necessary to select a part of the hull that is submerged under all load and speed conditions.

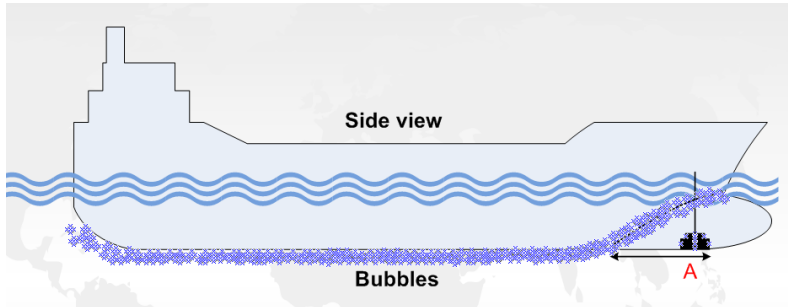

For 2 axis speed logs the transducer should be positioned as deep as possible on the hull. The transmitting surface of the transducer must be installed horizontally.

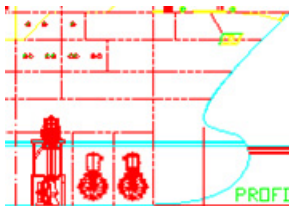

A typical recommended area for installation is fore part of the bow thruster room.

The sea valve with sensor can be installed in a balast tank, but it is not recommended. It is necessary to position the sensor on a hull section which will ensure a laminar water flow for all angles of measurement. If such a flat section is not available, the shipyard must construct a suitable bed. If the vessel is designed with a box keel, this can be used for installation of the sensor. In this case, special length hull fitting and sensor may be ordered from SKIPPER.

Before hull fitting installation procedure is initiated, always check that the hull fitting valve can be properly operated and that the sensor can be removed in the selected location. See installation manual for the valve solution for more information.

PART POSITIONING AND WELDING

Please see the installation manual for the valve or tank. Installation may differ between the different solutions available.

Paint the hull fitting as well as the hull itself with a suitable anti-corrosion/anti-fouling product, but **do not paint** :

- the protruding part of the sensor and electrodes.
- Inside of sea valve
- Moving mechanical components

SENSOR INSTALLATION

Please see the installation manual for the valve. Installation may differ between the different valve solutions available.

The sensor can be mounted and powered in air and water. Briskly rubbing the face of the sensor will show changes in values in the speed. It is very important that the sensor is mounted in the correct orientation, (especially single axis units). In a tank, the arrows should point forward. On a ball valve, the flat area should point on the port side.

Tip: Placing a large flat straight pole on the flat area will allow accurate adjustment. Alternatively a laser level can be used to get accurate orientation on a remote bulkhead.

Small errors in angle can be calibrated in the 2 axis version, but care should be taken to get this as accurate as possible. Each time the sensor is lifted or repositioned, the angular offset should be checked. The orientation should be as accurate as possible in the 1 axis version, as it cannot be adjusted electronically.

The JB60CD electronic unit has to be installed in a dry place on the bridge.

CABLING

System elements should be placed as in "[Interconnection diagram](#)" on [page 12](#). The sensor is supplied with 40 m of cable. This should be guided to a dry area where a junction box (yard supply or SKIPPER part JB12) should be used to extend the cable to the bridge. The sensor is a smart sensor and outputs propriety NMEA messages. This standard is based on RS-422, so cable lengths should not be a problem. The cable can be cut or extended. However, power is sent down the cable and the sensor should have at least 16 V at the sensor junctions box to function normally. The cable should be as follows:

Up to 40 m	Use supplied cable
Up to 100 m	4 twisted pairs min 0.5 mm ²
Up to 300 m	4 twisted screen pairs 1.5 mm ²
Up to 600 m	4 twisted screen pairs 2.5 mm ²
Over 600 m	Local 24 V supply to sensor at junction box is recommended

Although the signals on the cable are digital, it is recommended to avoid electrically noisy areas such as pneumatics and generators.

The JB60CD electronic unit is mounted on the bridge. The Compact display is supplied with 10 m of cable which can be extended to max. 20 m. This cable is connected to the JB60CD electronic unit connector J300. The sensor cable is connected to the JB60CD electronic unit connector J200. External inputs and outputs are connected to the connectors J301 and J400 as shown in diagram on next page "[JB60CD Interconnection Diagram](#)" on page 18.

POWER

Power to the electronic unit (JB60CD) supplies power to the whole system. The user has the option to use either or both AC 110-240 V, or DC 20-36 V supplies. Both can be connected at the same time. The JB60CD has automatic fuses which, if tripped, will reset when the fault is removed.

THE DIGITAL INPUTS AND OUTPUTS

(ALARM, PULSE, DIMMING)

The digital inputs and outputs of the system meet the standard requirements for IEC 61162-1. Inputs and pulse outputs are optoisolated as shown in "[JB60CD Connection methods](#)" on page 20. To make these work, it is necessary to apply a voltage and a resistance in series to the (XXXXX)A pin, as shown. The nature of this type of connection is such that the installation requires an external voltage (5-24 V) to function. A positive voltage is required on pin marked (XXXXX)A. GND or negative on pin (XXXXX)B. Common alarm output uses a standard relay are COM (8), NO (9), NC (10), on J400.

THE PULSE OUTPUT

A single pulse output is available. This pulses at a rate proportional to the longitudinal speed. (This is the required output for RADAR systems). The pulse is active high and the pulse length is 60 ms. This output is located on pin 9 and 10 on connector J301 and is attached to an optocoupler. To get a signal from this port, a voltage must be applied to pin (XXXXX) A (5-24 V). (The same as fit-out).

THE DIMMING INPUTS

Pulses of at least 60 ms on the dimming up and dimming down inputs (J400 pins 5, 6, 7) will cause the dimming to change by one level. The inputs are optocoupled and therefore require an external voltage to operate, (4 Volt -30 Volt (typically 12/24 Volt)).

Note: If the system is set up as CD401EB/DB, the dimming input (DIMUP/COM) are used for changing the speed direction and remote dimming is not possible.

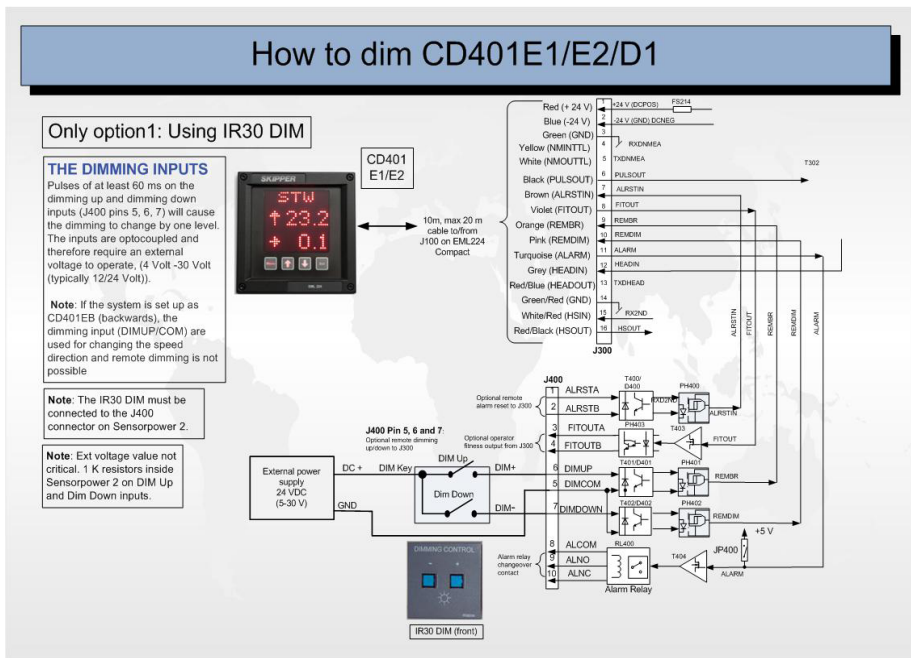

JB60CD INTERCONNECTION DIAGRAM

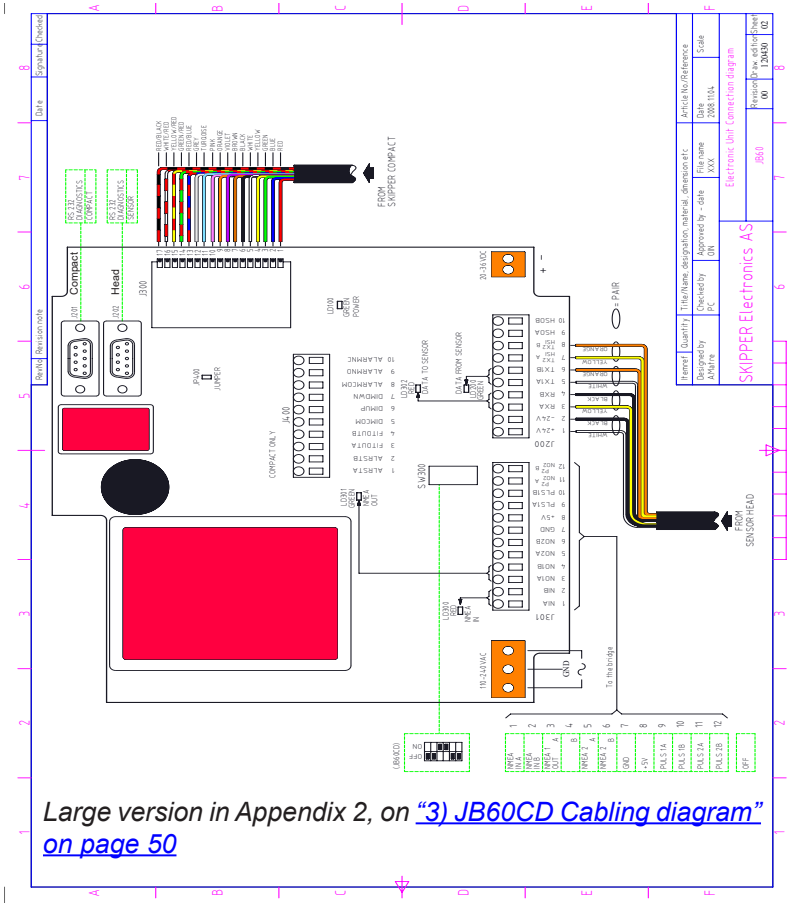

Item#	Quantity	Title/Name, designation, material, dimension etc.	Article No/Reference
Dispersed by	Checked by	Approved by	Date
Job/Part	PC	100	2008-11-14
File name	XXX	XXX	XXX
Scale			

Electronic Unit Connection Diagram

Revision	Rev. of the File
00	1.0000
00	1.0000

SKIPPER Electronics AS

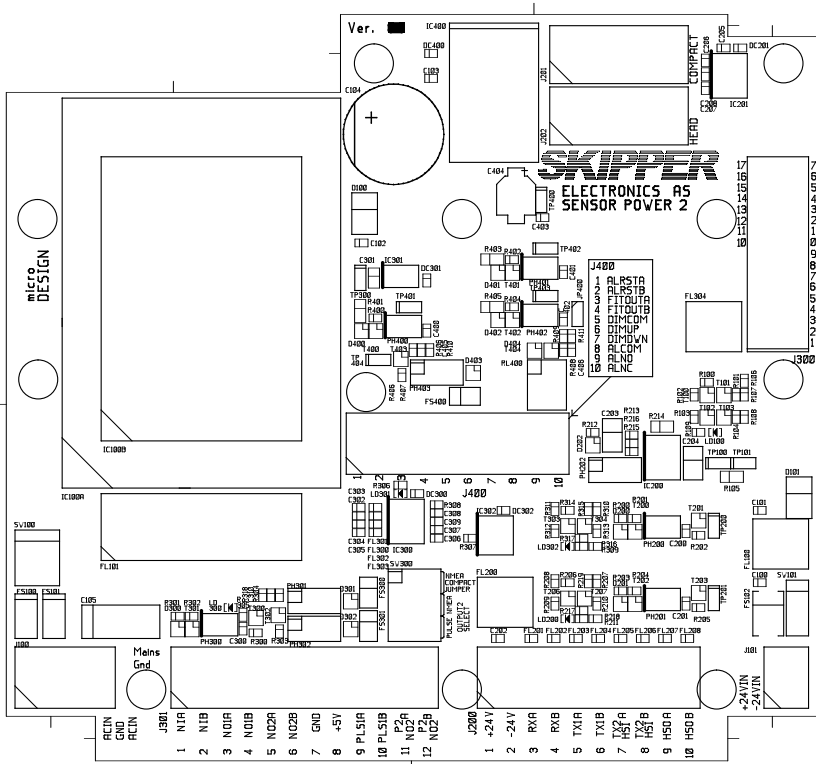

JB60CD CONNECTION METHODS

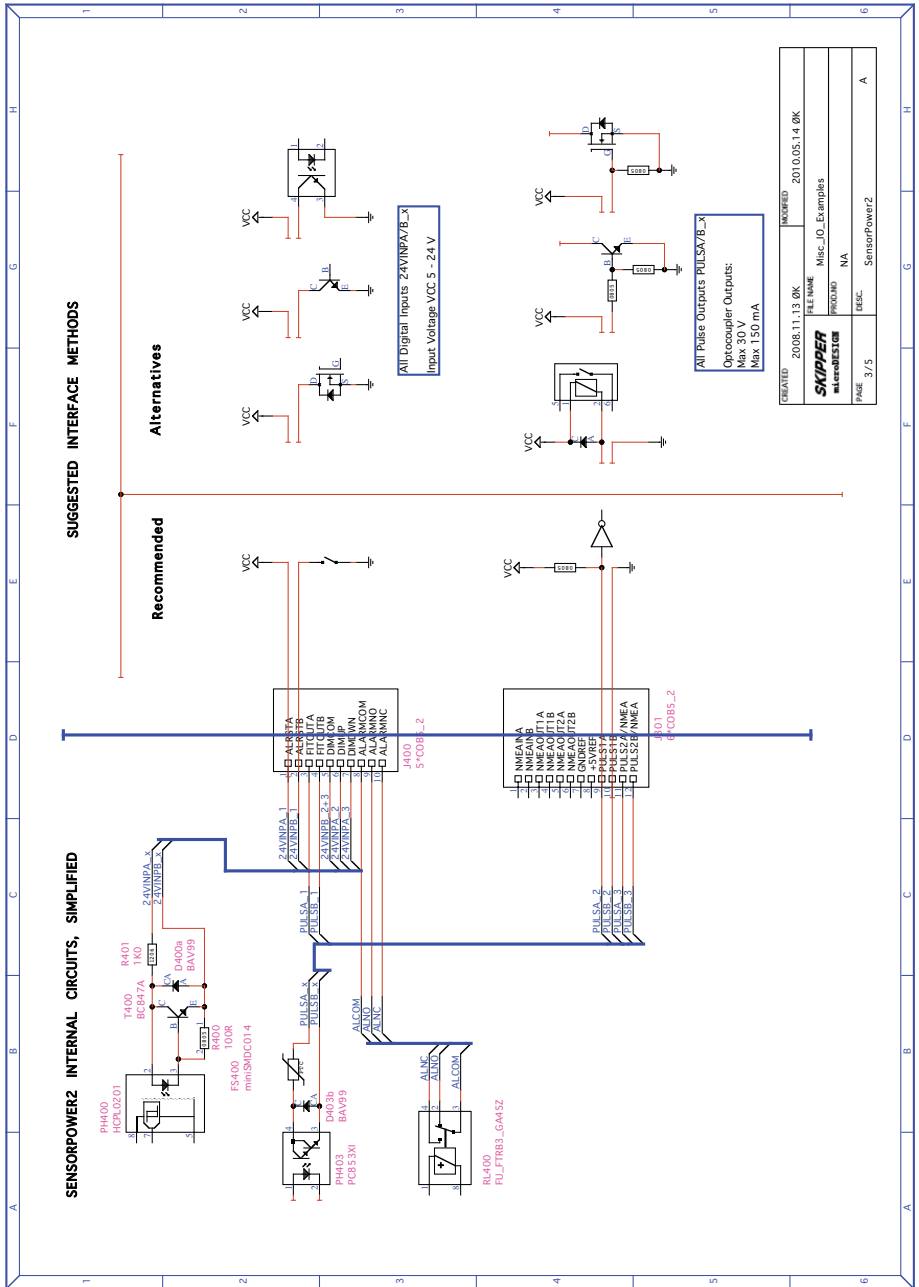

JB60CD-SA CONNECTION METHODS

TYPICAL NMEA 0183 CIRCUITS

Typical NMEA 0183 Input
Galvanically separated.
Revision 2.30 (1998):
Max Load Current = 2 mA at 2 V
Revision 1.9 (1985):
Must withstand ± 15 V

Typical NMEA 0183 Output
Revision 2.30 (1998):
RS422 Signal levels and Drive Capabilities.
Balanced Outputs 0 - 5 V nominal.
Balanced Outputs 0 - 3.5 V @ 30 mA.
Output current 30 mA.

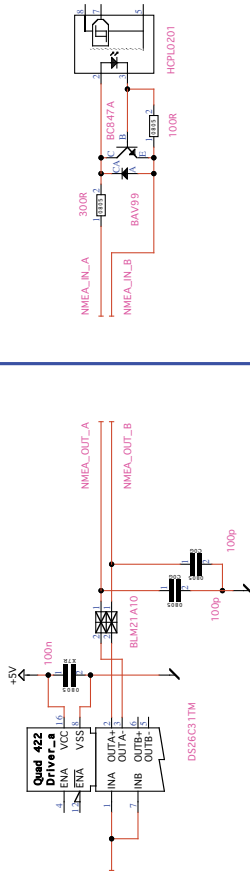

CREATED:	2008.11.13 ØRK	MIN/REV:	2010.05.14 ØRK
FILE NAME:	SKIPPER		
PRODNO:	misc_ID_Examples		
DESC:	NMEA I/O		
PAGE:	4/5	DESC:	NMEA I/O

SPEED DIRECTION (CD401EB-SB ONLY)

CD401EB-SB, SKIPPER 2 Axis EML with Backwards option, is a speed log display developed for vessels going in both directions, like ferry boats.

On this system the NMEA signal out to repeaters are reversable. The wanted speed direction can be switched by connecting the DIMUP-input to Vcc and connect a switch between the DIMCOM-input and ground. The screen will show the same direction but NMEA VBW will change polarity. The NMEA output sentence VMXDR is used to indicate the speed direction for the CD401EB-SB system. The VMXDR NMEA output sentence is sent if the VMVBW NMEA sentence output is enabled.

Note: Only multi repeater should be used in this mode. These read the XDR message and rotate the axis when required.

If DIMCOM is left open the VMXDR output will be (backward direction):

\$VMXDR,A,180,D,SPDD*hh<CR><LF>

If DIMCOM is grounded the VMXDR output will be (forward direction):

\$VMXDR,A,0,D,SPDD*hh<CR><LF>

A small arrow symbol is used in front of the STW text on the screen to indicate the configured vessel direction.



CHAPTER 2

SETTING UP THE COMPACT DISPLAY

PRINCIPLES

The CD401XX Compact display is a flexible dot matrix LED display designed to display navigation data. The display can be user programmed to show most kinds of numerical data, from NMEA messages or self generated. It can also be used as a primary sensor display for speed logs showing the speed values produced by the sensor or as a simple repeater. The Compact speed log system with its electronic unit (JB60CD) meets all the requirements of a primary device, both functionally and electrically. On its own, it meets the requirements as a repeater. The Compact display has three user definable alphanumeric displays, each allowing up to 4 parameters to be displayed. When the device is used as a primary device, some of these screens will be fixed.

RUN SCREENS

The unit starts up in run mode. By pressing MENU button, the preset user screens can be selected. Some of the menu screens (i.e alarms) are also available in the run mode. The unit can be dimmed in any of the run screens using the up (↑) and down (↓) buttons. If Trip/Total are selected as a displayed parameter, they can be toggled using the SET button.

SETUP SCREENS

To change the setup of the Compact display, the user must simultaneously press MENU and SET. This will give access to a menu system allowing the user to scroll up and down the sub-menus and functions using up (↑) and down (↓), and SET to select. To move to the previous menu, the MENU button must be pressed. The middle underlined line is the selected line, the other lines are dimmed.



The menu structure is shown in the diagram [“Menu diagram” on page 28](#). The menus are product dependant, only the relevant menus are accessible. However, some menus are always available. To leave the menu screens and return to the runtime screens press and hold the MENU button.

ACTIVATING THE RUNTIME SCREENS

The system has three user definable screens. Screen 1 may be locked in some configurations. In addition, the user can make the most common setup

screens available. The screen menu allows the user to configure and choose which runtime screens to be included in normal operation. UP (↑) and DOWN (↓) buttons will scroll to the available screens. By using the SET button, the user can control each individual screen to ON or OFF. Screens set to ON are available to be displayed by pressing the MENU button. Screens set to OFF will not be displayed.

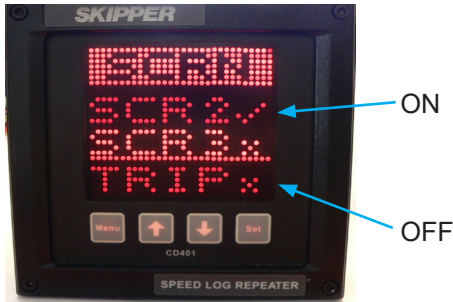

CONFIGURING OF DATA SCREENS

The three user programmable screens can be set up using the configuration (CONFIG) menu. This submenu allows the user to select one of the three displays. On entering the CONFIG screen, the user can change the data type to be displayed in each of the 4 screen positions. Up (↑) and down (↓) will change the data type, SET will move to the next screen position. The screen layout will depend on the selected data type. Up to 4 lines of text and data can be displayed on each screen. Placing TXT in the bottom 4th line or 3rd and 4th line will cause the data to spread out showing fewer data points. The system will not allow you to mix speed data from different sources on the same screen. Having 2 TXT lines after each other will also rearrange the positioning.



Note: The Compact speed log system needs one screen which indicates just the primary data. This screen is fixed and cannot be adjusted.

The non-active parameters will continue showing the dimmed title data, when not selected.

Example:



Configuration screen



Runtime screen



Configuration screen



Runtime screen

SETUP OF INPUTS AND OUTPUTS

The system will allow many NMEA formats to be displayed:

VMVBW	Speed long, trans, forward water speed
VMMTW	Temperature (water)
VMVLW	Trip/Total (distance sailed)
VMVHW	Speed through water (resultant)
DIAG	Diagnostic output (all others deactivated)
VMXDR	Vessel (sensor) direction (CD401EB only)
VMALR	Alarm messages

Definitions of sentences are available in ["Appendix 3"](#) on page 56.

The system will automatically update recognised formats. If the user wishes to output NMEA, the user can select the NMEA sub menu in the SETUP menu and move to the different formats using the up (↑) and down (↓) buttons. Each format can be activated/deactivated using the SET button.



AVERAGING

Each speed log type has some filters to ensure stable and correct data. The averaging filter takes a number of measurement pulses and makes a rolling average of these values. The longer the averaging is, more stable the data will be. However, the slower the system will respond to changes.

The Compact speed logs have a minimum value of 10 seconds. If the system seems unstable at times, increasing the average time will reduce the fluctuations. However, the filtering is time based and as it increases, the response time of the system will decrease.

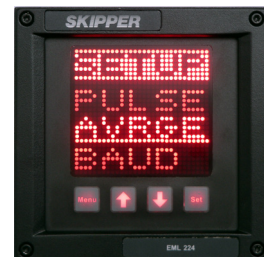

CHANGING THE BAUD RATE

The NMEA 0183 (IEC61162-1) standard is 4800 baud. Some vessels run with higher baud rates. 4800, 9600, 19200, 38400, 57600 and 115200 baud rates can be selected in the baud page of the setup menu. This page contains two sub menus, one for the sensor and one for the NMEA port. It is recommended that the sensor is kept to 4800, as this speed is robust with longer cables. To switch between sub pages, the SET button is used. The baud rates become active when you leave the baud page.

DL1 MODES OF OPERATION

(DL1 only)

The default mode of operation is designed to work in nearly all conditions. Other modes are available to give better accuracy in deeper water or to measure water without bottom influence in very shallow water (down to 2 m), standard is 3 m. Setting 1 is for shallowest data, and the higher settings gradually increase the depth (max 12.5 m).

NOTE: Wheelmark requires measurement possibility to 3 m depth.

DEMO MODE

A demo mode is available, and can be activated in the diagnostics menu. Three/ four modes are available:

Mode 1; is a **dynamic demo mode** taking the present value as the start point and slowly varying all the available values.

Mode 2; is a **static demo mode** taking the present values and keeping them active.

Mode 3; is a **fixed speed** longitudinal 5 kn, transversal 1 kn.

Mode 4; (DL1 only) Adjusting the speed in this mode will cause the DL sensor to transmit acoustics with a frequency offset equivalent to the speed you enter. The second channel will receive that signal and process the data proving the system is working. This will test the whole system. To activate/deactivate or change speed in this mode you must press SET.

When the demo mode 1-3 are active, the sensor signal is ignored, and the screen will indicate the demo state with a blinking S in the upper right corner of the screen. The user can turn off the demo mode from the demo screen by pressing down (↓) button until OFF is shown in the screen, or the demo mode will turn off automatically after 10 hours.

ALARMS

The Compact speed log does not contain any alarms except for Common Alarm (Power failure) That is connected to the Relay output J400 pins 8,9 &10. As there is no requirement for any other alarms, these have been removed to conform to recent changes in standards

MENU DIAGRAM

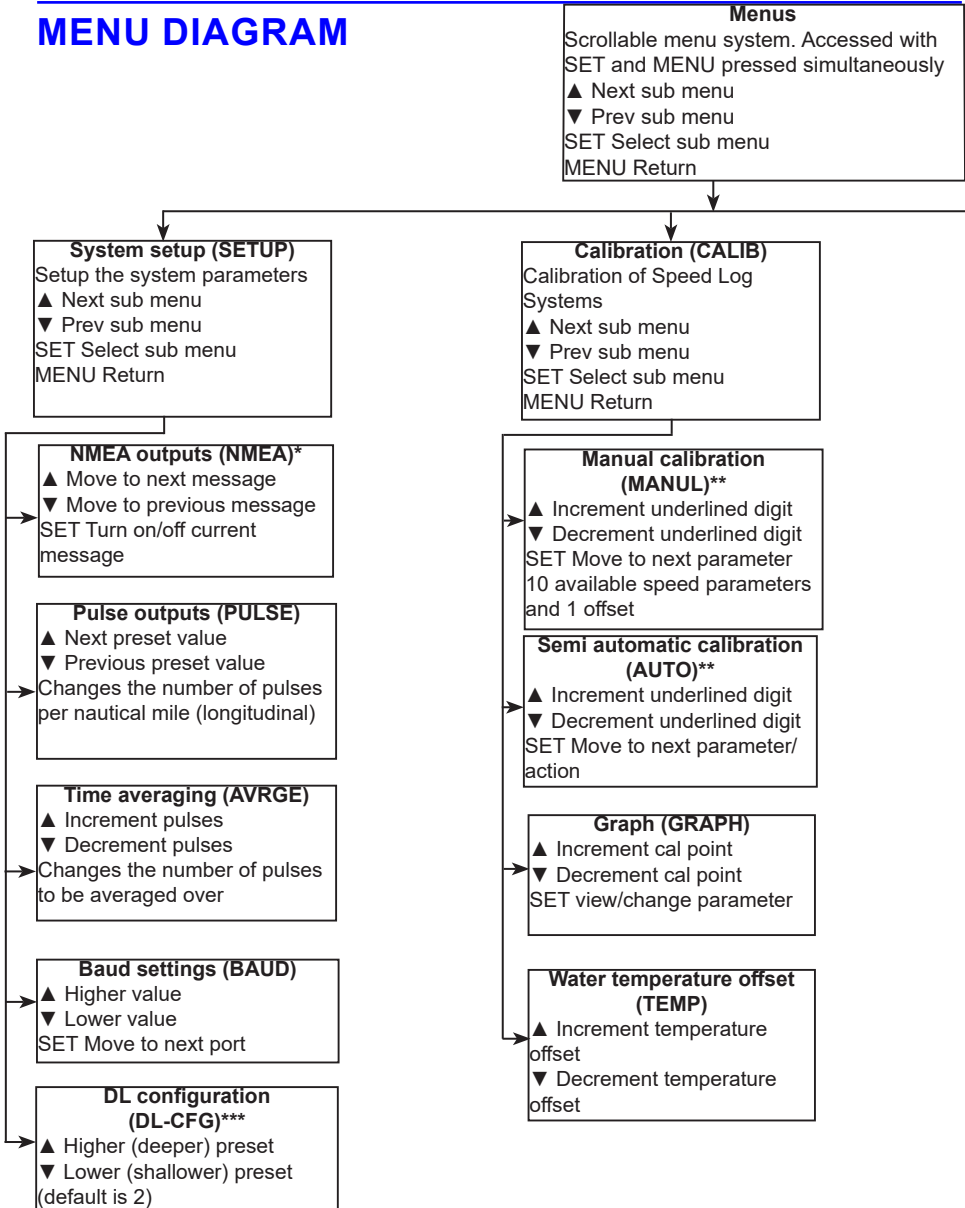

* One option in the NMEA settings is DIAG. This turns on some of the diagnostics outputs. These are propriety messages that occur if an error occurs or if requested. Setting this to 'ON' will stop all other messages.

** Offset calibration not available in single axis system.

*** DL configuration: only available on DL1 system.

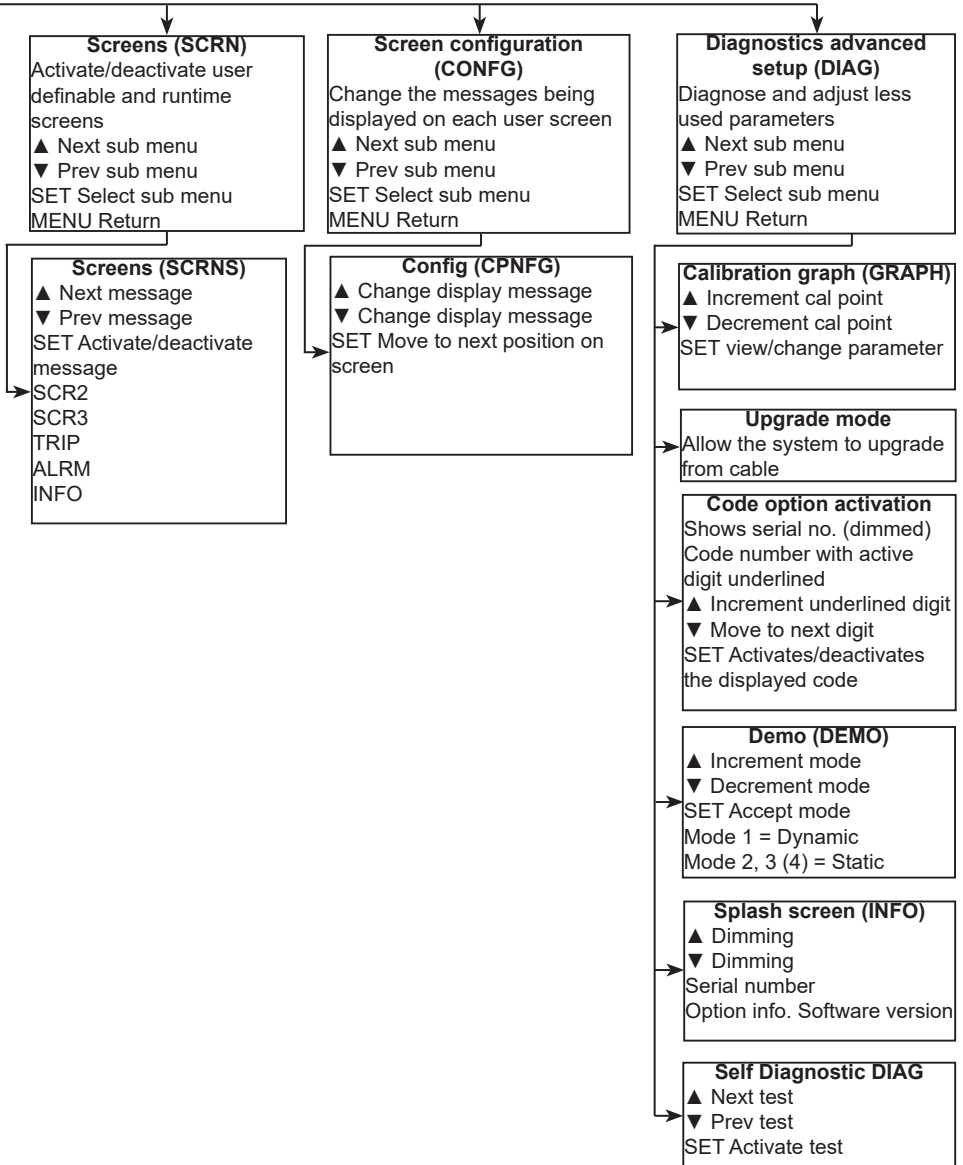

CHAPTER 3

CALIBRATION

THE PRINCIPLES

Calibration of a speed log involves finding the mounting angle of the sensor (heading offset) and the speed error at various speeds.

If the vessel has a laminar water flow near the sensor, a single calibration point will be sufficient. If the flow changes with speed, (due to the friction of the hull, or nearby constructions) then extra calibration points will be required. The sensor is mounted on a pole that can be turned to adjust the angle. This may result in a small angular error. This can be calibrated away in the 2 axis version, but not in a single axis version. This should be done before the main calibration procedure is performed.

Calibration parameters

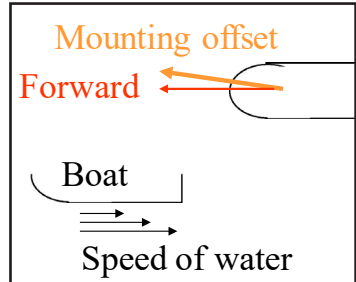

Full calibration is designed to ignore water current effects. The procedure requires the vessel to sail a fixed length track at a constant speed. To remove the current and wind effects, the same track should then be sailed in the opposite direction at the same speed. The average of these tracks will be used to calculate the speed difference between the real speed (measured using the actual distance and the time it took), and the measured speed (using distance from the sensor and the time it took). This procedure must be performed at least once and then other speeds checked with the GPS.

A

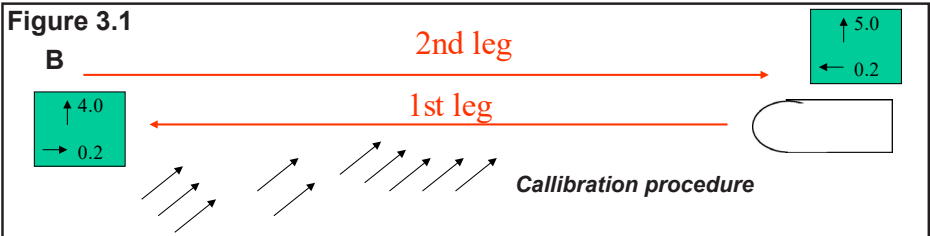

If necessary, the procedure should be repeated at different speeds. SKIPPER recommend that calibration is performed at a low speed and a high speed. If the user is not able to turn the vessel and is sure there is no current, the calibration procedure can be stopped after the first leg and saved as a calibration point. This will give values that are correct for that particular condition. (If current is present, the speed through water will contain an error).

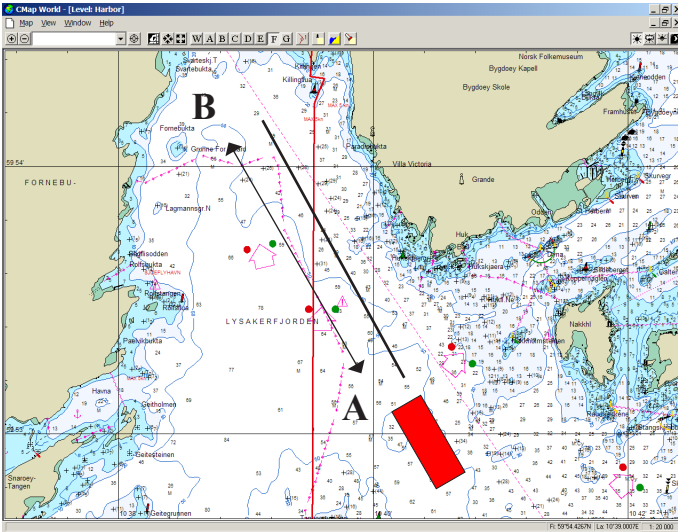

Figure 3.2
Shows plotting a calibration path on the chart.

The leg should take at least 5 minutes to sail (distance can be shorter when sailing slowly).

Reducing heading errors. New generation sea valves can be manually adjusted to ensure the sensor is correctly aligned. Alignment and heading offset are directly connected. To minimize the offset, the sensor should be mounted pointing ahead.

- **Tank mountings** have ahead marks on both the tank and the sensor insert.
- **Sea valves** have either a mark on the top flange or a flat mark on the port side of the pole which when a flat object is placed against this, will point fore/aft (figure 3.3).

Figure 3.3

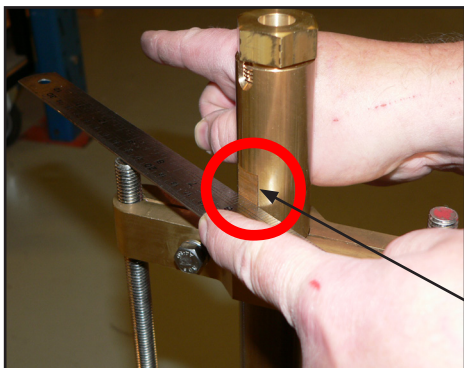

A flat object points fore/aft.

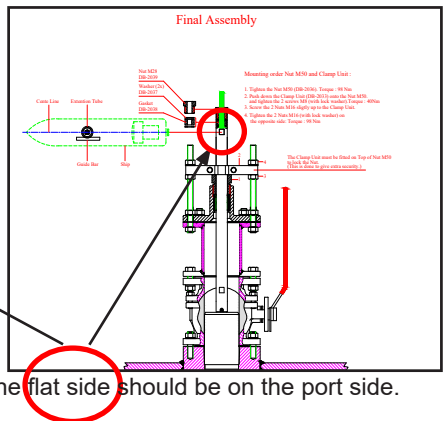

The flat side should be on the port side.

SPEED CALIBRATION MODES

The EML224/DL1 Compact has two modes of speed calibration:

1. Manual
2. Semi-automatic



Manual mode

The calibration – (MANUL) menu will allow the user to adjust the heading offset (*see note below), and the speed calibrations individually. Up (↑) and down (↓) adjust the highlighted parameter. SET moves to the next parameter. The data showing the result of the change will be displayed dimmed on the same screen (offset or speed). On the 3rd press, the lower value will change from Measured or Raw resultant value (Mrs) to Calibrated resultant (Crs) to allow the user to check the result of the change.



*Note



Procedure

When entering the manual mode, you will be presented with the offset value. This is the mounting angle of the sensor. The bottom line shows the measured offset at this moment. Adjust the middle value until the bottom value is near zero. Note the bottom value has a long average, and you may have to wait for up to a minute for the value to stabilise.

***Note:** This function is only available in dual axis systems.

Hint: Pressing down (↓) and SET together will change the current selected value to the resultant value, or to zero, saving time when adjusting.

Pressing SET moves you to the next speed calibration. Enter the real (R) speed and measured (M) speed, (the measured speed can be seen on the bottom line). The calibrated value can be checked by pressing SET one more time. Repeat this process at as many different speeds as necessary.

Semi-automatic mode

The calibration – AUTO menu will take the user step by step through the calibration menu. The user may follow the steps presented on screen. First drawing a line on the chart system, as shown in figure 3.1 and 3.2.

- The line should be sailed at constant stable speed and the line should represent at least 5 minutes of sailing at the current speed.
- **Leg length setting.** (Adjust the length to match the line drawn on the chart).
- **Start first leg.** (The vessel crosses point A at the calibration speed, towards point B).
- **Stop first leg.** (The vessel reaches point B on the chart and turns to sail the line in the other direction).
- **Save first leg.** (If the presented speeds look correct, save the leg and continue).
- **Second leg, option.** (If you do not have the possibility to turn the vessel, you can use the first leg data directly. If the first leg data is of poor quality, you may not be given the option to continue).
- **Start second leg.** (The vessel crosses point B sailing towards point A, sailing at the same speed as leg 1).
- **Stop second leg.** (Press as the vessel passes point B)
- **Calibration result and save option.** (The user can decide to accept or reject this calibration, and in which memory position to save it).



*Note

The user may decide which of the 10 calibration points the calibration will be saved in. The screen will display the first available position on the table, or overwrite from zero upwards.

***Note:** The single axis version (CD401E1/D1) of this product does not have the transversal axis available and will not require offset calibration. However, it is highly important that the sensor is mounted pointing forward. If mounted in a valve, the pole can be rotated whilst moving the vessel against any current to maximize the longitudinal speed. This should be ahead.

CHECKING THE SPEED CALIBRATION

To check that the calibration points are not too far from the ideal linearity, the Calibration – GRAPH menu will plot the calibration points on the screen. The user may use up (↑) and down (↓) to select a calibration point and then adjust that value by pressing SET on the relevant point. The MENU button will return you to the GRAPH menu again.

Calibration should occur or be checked whenever the sensor is moved, or a new sensor is mounted. If there is growth on the sensor over time, the speed may be reduced slightly. The system should then be re-calibrated.

Note: If a new sensor is mounted, the calibration in the Compact speed log may be useable. However, it should be checked.



WATER TEMPERATURE OFFSET

An offset can be added to the measured water temperature from the DL1 sensor. The calibration is a linear offset to the measured value. The calibration – (TEMP) menu will allow the user to adjust the water temperature with an offset value. Both calibrated (C) and measured (M) temperature are shown on the screen.



CHAPTER 4

RUNTIME OPERATION

RUNTIME SCREENS

The Compact speed log system starts up in run mode. By pressing the MENU button, the preset user screens can be selected. (See [“Runtime diagram” on page 36](#)). Some of the menu screens (i.e alarms) are also available in the run mode.

The EML224 Compact can be dimmed in any of the run screens using the up (↑) and down (↓) buttons.

If trip/total are selected as a displayed parameter, they can be toggled using the SET button.



RUNTIME DIAGRAM

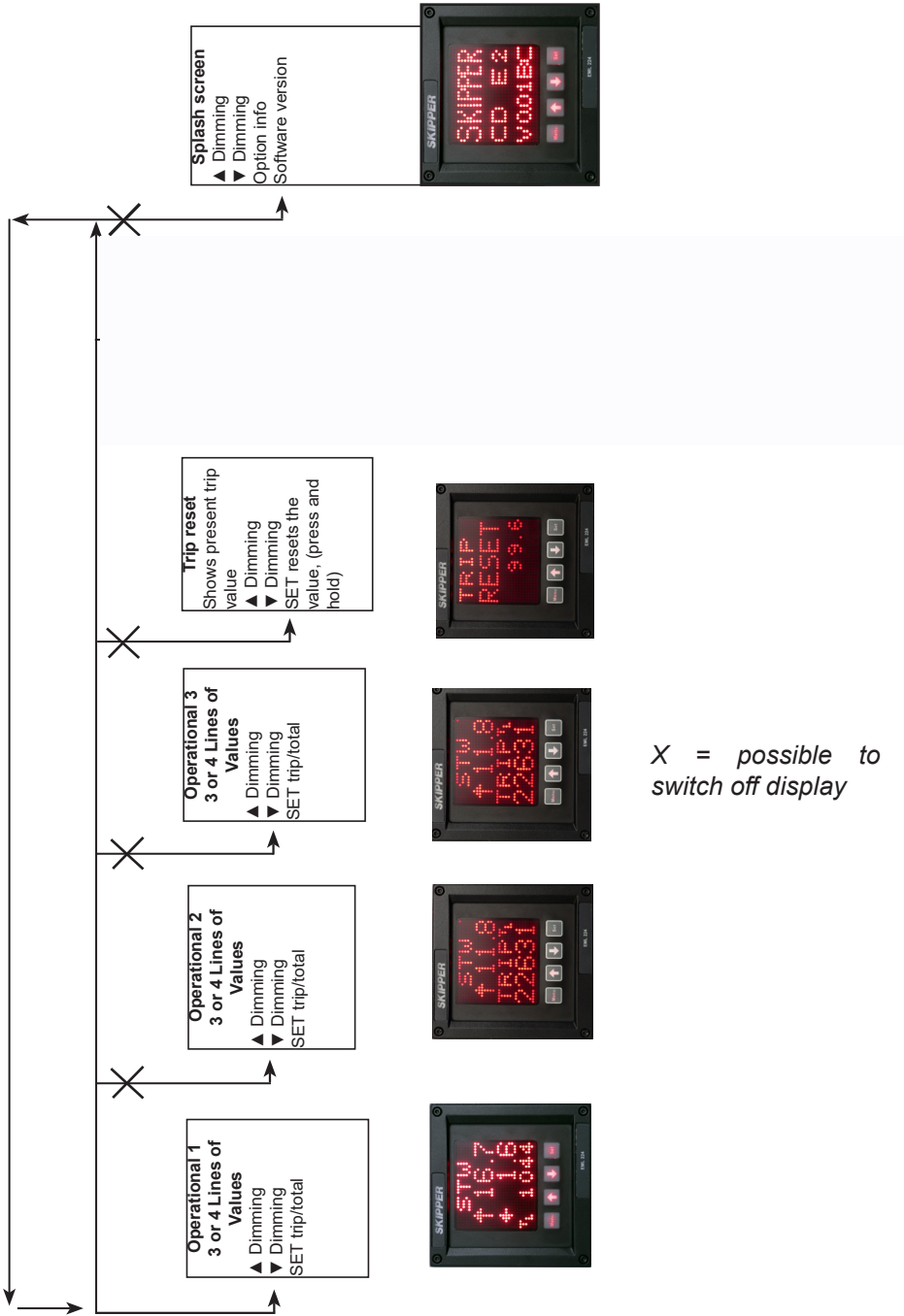

CHAPTER 5

CHECKING OUT YOUR SYSTEM

Certain conditions may effect the results of your system. The EML may with time, reduce in speed due to growth on the metal pins. This can be calibrated away (should be cleaned regularly).

The DL1 system requires less maintenance.

The DL1 system, by default, measures the speed through the water from depth 0.25 m to 3 m. If the water is shallower than 3 m, an element of the bottom speed may influence the results. This may be improved by changing the settings to position 1. The Doppler measurements in the DL1 will be affected by water temperature. However, this is compensated internally. Both systems may suffer from reduced performance in high seas or in water containing many bubbles. The EML may see a slightly reduced speed in area of extreme fresh water <5 ppt salinity.

If you suspect something may be wrong with your Speed Log, the system has possibilities to perform self diagnostics. This is available in the diagnostics menu. In addition, an up to date diagnostics guide can be downloaded from the support pages of www.skipper.no. Also, a SKIPPER service software is available for download providing diagnostic support.

SELF DIAGNOSTICS

The Compact speed log contains some diagnostic features to enable the user to decide which part of the system is failing. The last 20 errors are stored in the system and can be downloaded using the diagnostics port. If the error is serious, the system will cause a general alarm (if activated), and restart itself. Error numbers can be found in [“Appendix 5” on page 58](#).

Test No.	What it does	What is wrong?
0	All LEDs dimming SET = on/off	Check for LEDs not working. Check normal screens for rows or LEDs sticking.
1	Check internal memory.	If fail, the system is not able to communicate with the internal flash memory.
2	Send out a command to sensor and wait for response or same message back.	If fail, either the output or the input to the sensor is not working or the sensor is failing.

Test No.	What it does	What is wrong?
3	Write out 80 characters to NMEA, ask user to press if ok, or read back.	Manually check the output. If fail, try to restart.
4	Write out 80 characters to SENSOR, ask user to press if ok, or read back.	Manually check the output. If fail, try to restart.
5 - loop	Turn on alarm - wait for reset or loopback.	The user or loopback should reply to the alarm by pressing the alarm reset, (works only in test configuration).
6 - loop	Pulse out sends a pulse. If looped back to dimming up, this test will pass.	Fail implies the pulse out or dimming up is not working. Try individually, (works only in test configuration).
7 - loop	Fitness out sends a pulse. If looped to dimming down, this test will pass.	Fail implies the fitness out or dimming up is not working. Try individually, (works only in test configuration).
8 - loop	Test NMEA baud 4800, 38400, 115200. (Only passes if looped to the input).	Fail implies one of the speeds is not working correctly. (Works only in test configuration).
9 - loop	Test sensor baud 4800, 38400, 115200. (Only passes if looped to the input).	Fail implies one of the speeds is not working correctly.
10	Status of transducers (Doppler only).	

Tests 5 - 9 are designed to be smart by sending and receiving information at the same time. They require loopback or the user to enter the expected reply. These tests are primarily for factory use.

TEST POINTS WITHIN THE SYSTEM

In addition to the internal system testing, it is also possible to connect a PC with a COM port to the 9 pin RS-232 "COMPACT" DSUB in the JB60CD electronic unit. By using hyperterminal, many additional features can be checked.

It is also possible to see what is happening within the system by observing the LEDs inside the JB60CD electronic unit. (See diagram on ["3\) JB60CD Cabling diagram" on page 50](#)).

Here you can check if the sensor is operational.

LED	Colour	Description
LD 100	Green	Flickers with each measurement.
LD 200	Green	Flickers with data coming from the EML sensor.
LD 302	Red	Flickers with data being sent to the sensor (not so common).
LD 301	Green	Flashes with each NMEA out transmission to navigation system.
LD 300	Red	Flashes with data arriving from the navigation systems.

NOTE: The LEDs will work even if the NMEA inputs are connected with the wrong polarity. In the correct configuration, they are typically on and flicker.

LOGGING DATA

No internal data logging is available, however, a diagnostics NMEA can be logged on the standard NMEA port, or on the COMPACT plug in the electronic unit (JB60CD).

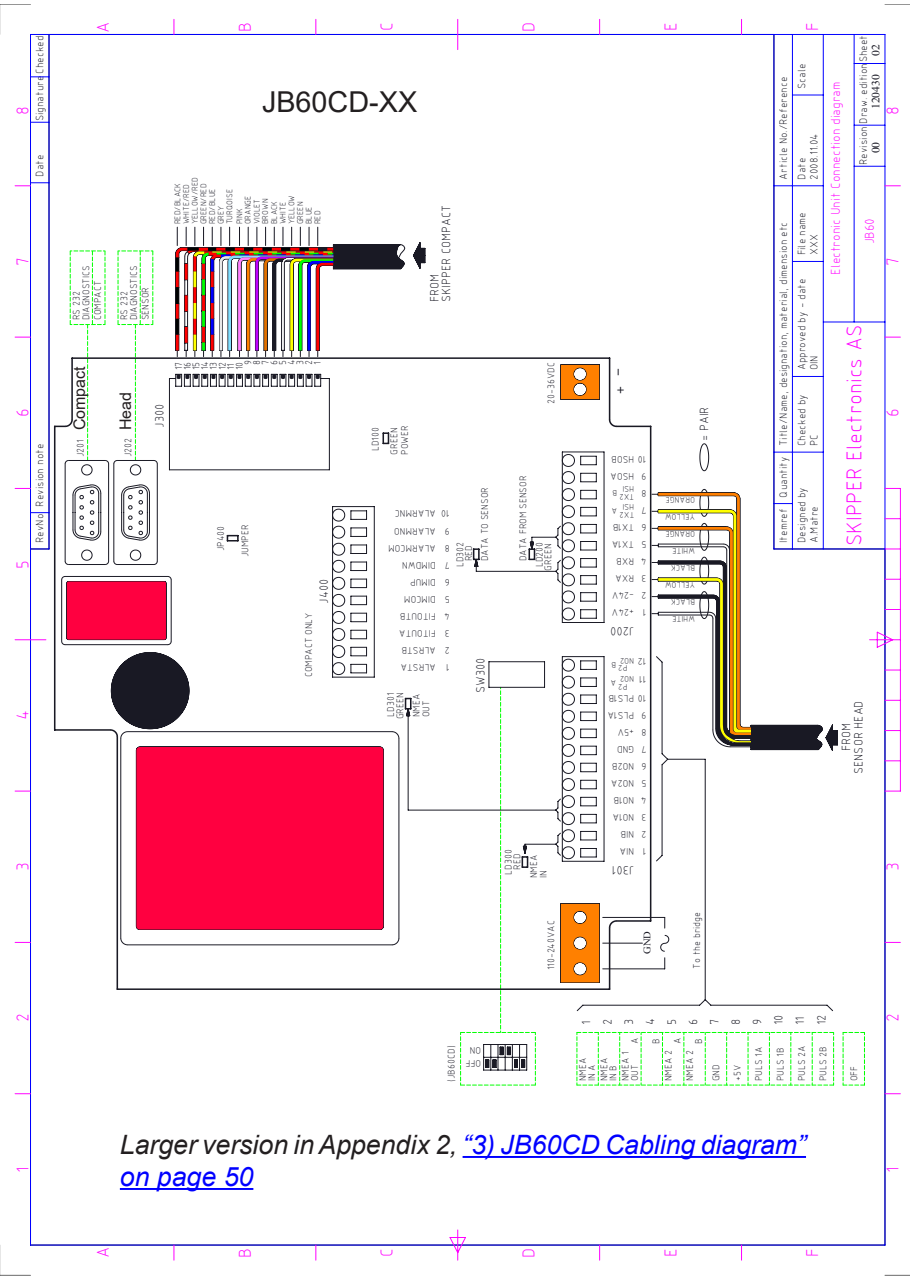

Larger version in Appendix 2, "3) JB60CD Cabling diagram" on page 50

Rev.No.	Revision note	Date	Signature	Checked
SKIPPER Electronics AS				
Checked by:	Approved by - Gate DN	File Name	Scale	
Reference	Quantity	Title/Name, description, material, dimensions etc	Article No./Reference	
	00	JB60	2086.1104	02

CHAPTER 6

MAINTENANCE

ROUTINE MAINTENANCE EML

If the EML 224 sensor begins to underestimate the vessels speed, there may be growth forming on the pins. These pins are made of a resistant, anti-rust metal. If the unit is powered off, or the vessel is stationary for longer periods of time (particularly in warm water), the growth may occur. This can be carefully removed by lifting the sensor if a valve is installed, or by divers or in dock. The pins must have electrical contact with the sea water, and **MUST NOT** be painted. The system may be unstable for up to 6 hours after the pins have been cleaned while a new oxide coat forms. The pins of the EML sensor should be typically cleaned every 6-18 months depending on conditions.

ROUTINE MAINTENANCE DL1

The DL1 Doppler system requires virtually no maintenance except cleaning when docked, and occasional greasing / testing of the moving parts of the valve.

CHECKING YOUR VERSION

If the info screen is activated on the run screens, the system type and software version can be read from there. Otherwise the same screen can be obtained in the diagnostics menu. The system type will be one of the following:

CD E1	EML 124 compact display 1 axis
CD E2	EML 224 compact display 2 axis
CD EB	EML 124/224 compact display "Reversible" mode
CD LR	Log repeater compact display
CD MR	Multi repeater compact display
CD MB	Multi repeater compact display "Backwards" mode
CD D1	Doppler Compact display 1 axis

The system will be locked to one of these setups, but can be changed to one of the other systems (with an additional cost) using a code (see ["Appendix 5" on page 58](#)).

SOFTWARE UPGRADE

The system is undergoing continuously improvement, and periodically new software will be released. These can be found at the download area of the

SKIPPER website (www.skipper.no) and may be downloaded and the system upgraded using a PC connected to the 'Compact' COM port in the electronic unit (JB60CD). Alternatively a chip can be supplied (with an additional cost) with the new software. This is changed by removing the backplate of the display unit.

To upgrade the software, select which com port is to be used (for JB60CD electronic unit 'Compact' DSUB use 'COMPACT' port, and select SENSR for upgrade). Ensure the line is clear by removing power from the EML sensor. Press set and restart the system. The unit will wait for new firmware for two minutes. After that it will start with the existing code. You may then start the SKIPPER service software (downloadable from the SKIPPER website), select the Compact display window, and then use the upgrade button to upgrade the unit.



MASTER RESET (FACTORY DEFAULT SETTINGS)

The factory default settings can be restored by performing the following operations:

1. Select CODE in diagnostic (DIAG) menu.
2. Press the SET button (**Note:** Do not change code value, just press the SET button.)

The unit will now restart with factory default settings.

Note. On Compact speed log systems, this will also **reset** the stored calibration values. We therefore recommend to write down the values before attempting this.

APPENDIX 1

BACKGROUND INFORMATION

EML224.

The EML224 Compact system works using Kirchoffs right hand rule (based upon Faradays law of generators) which states that a conductor (sea water) moving through a magnetic field (generated in sensor) will produce a current orthogonal to both field and movement. So movement of the vessel through sea water with at least 5 ppt salinity will produce a current across the pins orthogonal to the ships motion.

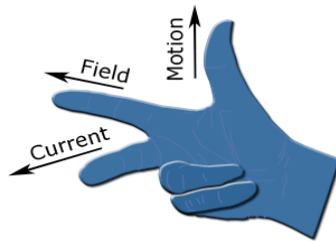

This minute current is measured and converted to a speed. This is formatted into propriety NMEA VBW format and sent to the EML 224 Compact display which applies an angular correction for both transversal and longitudinal speed, and then a scaling factor is applied for the resultant speed.

Inside the EML224 smart sensor.

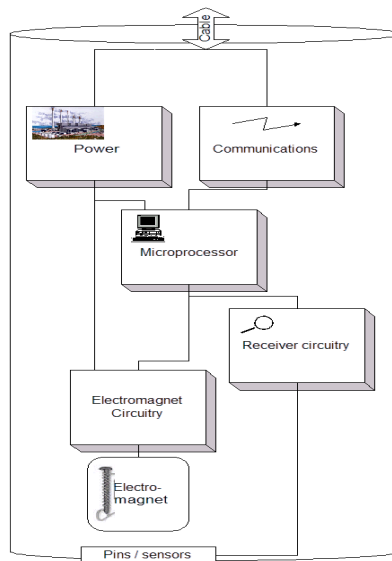

Doppler DL1.

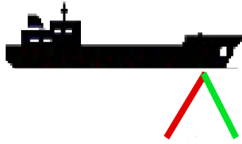

The Doppler system operates by sending a known frequency sound into the water, and listening to the reflected echo from the minute particles in the water. If the particles are moving towards the sensor, the frequency goes up, if away, the frequency goes down. By having two beams at 30 degrees from the vertical we get 2 frequency values, one plus, one minus, and these can be adjusted to show the speed of the vessel in the horizontal plane.

As the amount of particles in the water can vary, the system ensures it has optimal signal return by adjusting the power and length of the sample, depending on depth.

How calibration works.

Calibration is piecewise linear, i.e. a linear line is plotted from calibration point to calibration point (sorted by size) and this linearity is applied to the incoming values. This can be seen on the graph screen.

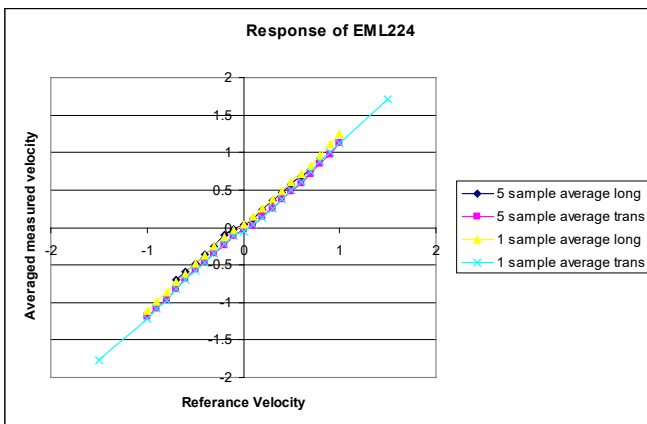

Calibration graph



APPENDIX 2

MECHANICAL DRAWINGS

To help planning and installation, the following diagrams are supplied.

1. System overview diagram
2. System specifications
3. JB60CD Cabling diagram
4. JB60CD Mounting diagram
5. Compact display mounting diagram
6. Compact display connection diagram

In addition, further guides for mounting of your particular hull mounting can be found at www.skipper.no.

1) SYSTEM OVERVIEW DIAGRAM

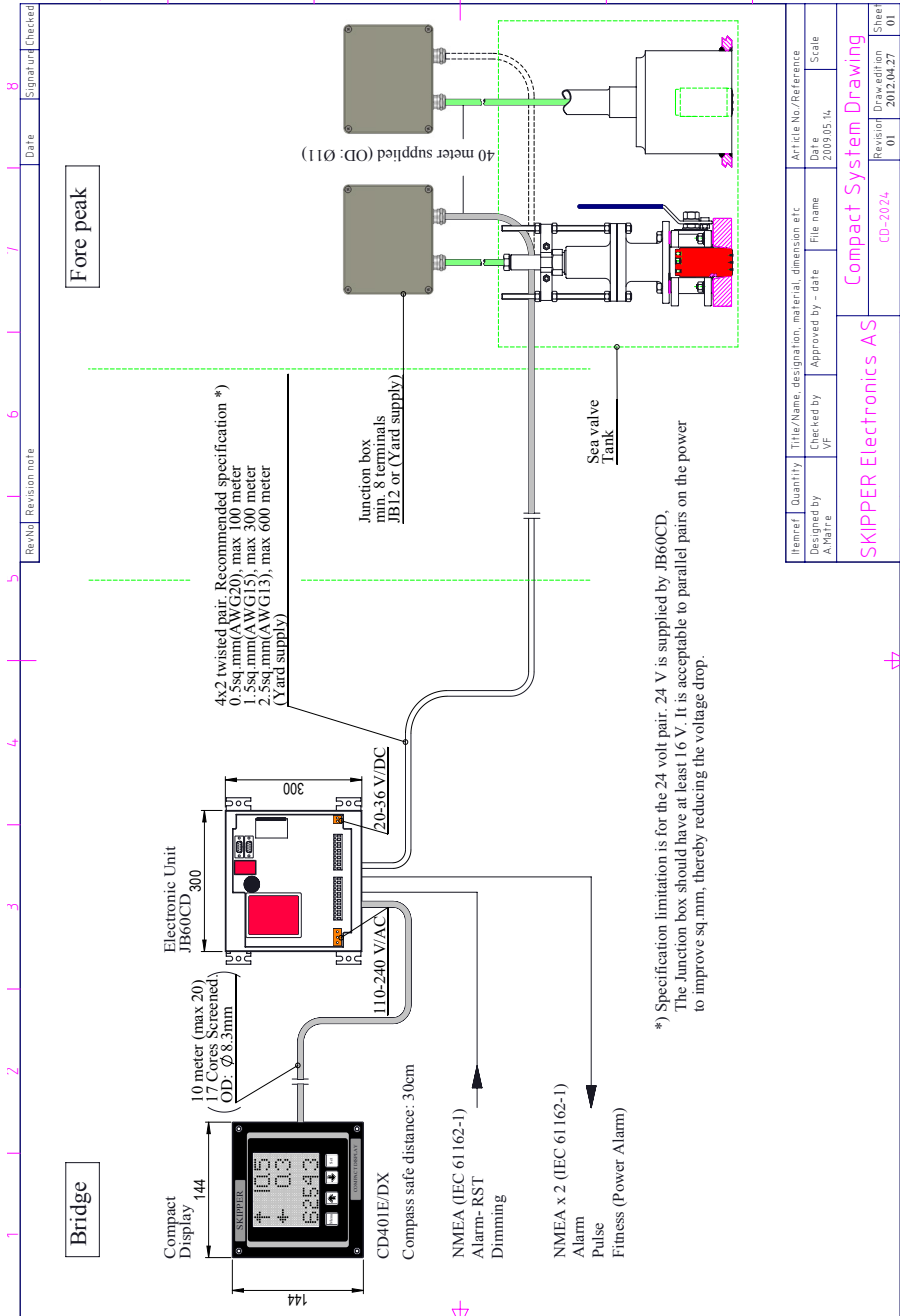

2) SYSTEM SPECIFICATIONS

	SY-EML124C Single axis	SY-EML224C Dual axis	SY-DL1 Single axis
Log			
Number of axis	1	2	1
Speed range long (knots)	±40	±40	±50
Speed range trans (knots)	na	±40	na
Water track (from) (meters)	0	0	0.25 m
Accuracy (better than) (knots)	0.2 or 2 % (whichever is greater)	0.2 or 2 % (whichever is greater)	0.2 or 2 % (whichever is greater)
Speed resolution	0.1	0.1	0.1
Temperature accuracy (°C)	< 1	< 1	< 1
Temperature resolution	0.1	0.1	0.1

Mounting

	SY-EML124C / SY-DL1. Single axis	SY-EML224C. Dual axis
Sea Valve		
Single bottom	Yes	Yes
Double bottom	Yes	Yes
Tank		
Steel	Yes	Yes
Aluminium	Yes	Yes

Display

	SY-EML124C / SY-DL1. Single axis	SY-EML224C. Dual axis
Weight (display)	1.3 kg	1.3 kg
Cable length display to JB60CD	10 m	10 m
(Max)	20 m	20 m
Compass safe distance (min)	30 cm	30 cm

Alarms

Speed alarms	High and low speed alarm
--------------	--------------------------

System alarms	System error alarm
Other alarms	Fitness (deadman) out or power failure
On screen indication of lost/corrupt data	

User defines inputs/outputs

Outputs	2 x NMEA (IEC61162-1)
	1 x contact closure (pulse)
Inputs	1 NMEA (opto isolated)
	External dimming (pulse) Time

Accepted NMEA (IEC61162-1) formats

Outputs	
Speed	VBW, VHW*, XDR**
Distance	VLW
Others	MTW (temp)
Inputs	
Time, Dimming	ZDA, DDC
Power Supply	AC: 110 to 240 V 50/60 Hz. (Automatic detect) DC: 20-36 V
Power Consumption	Max. 35 W
Display	28 x 30 pixel alphanumeric LED (red) with dimming.
Languages	English.
Accessories	IR300 Speed, CD401LR, CD401MR
	Dimming control
Classification	IMO MED D, MED B,
	Also meets OSV requirements
Service	Available in most major harbours world-wide through extensive dealer network.

*The Compact EML124/DL1, has only longitudinal output and will therefore only give that information within the NMEA outputs.

**The Compact EML224 Backwards uses a XDR sentence with an angular displacement of either 0 or 180 degrees for transducer no. 1 to indicate the direction. The transducer ID is SPDD.

This page intentionally left blank

3) JB60CD CABLING DIAGRAM

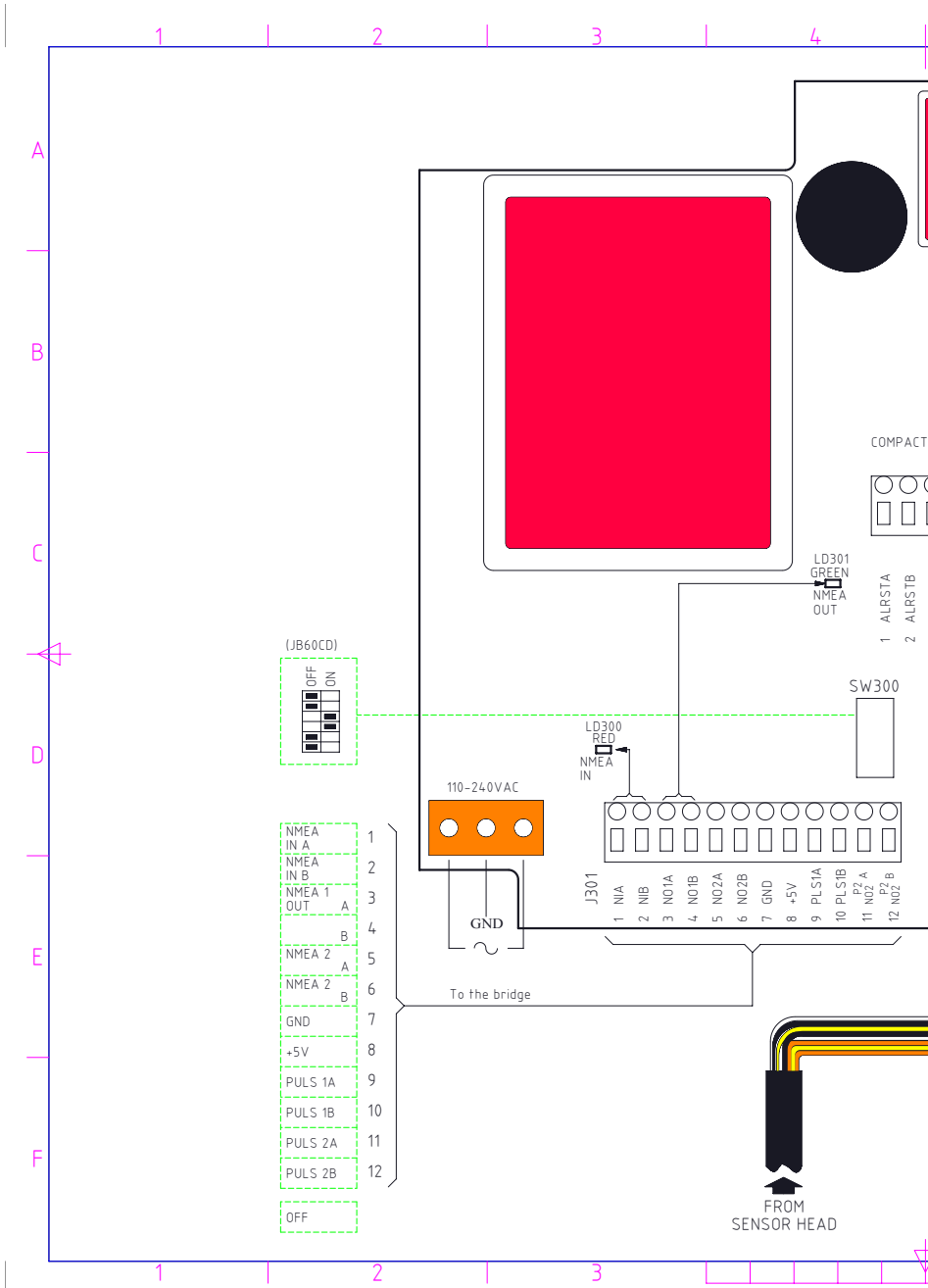

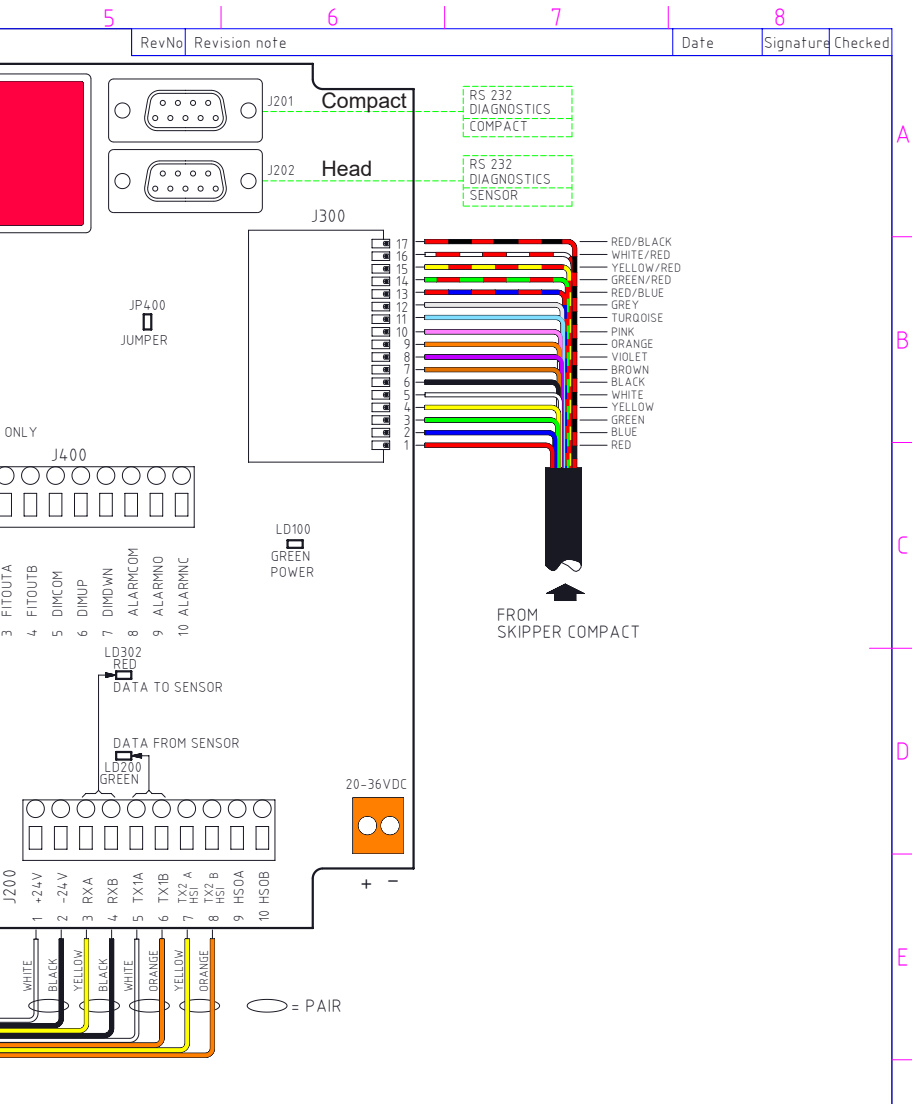

Itemref	Quantity	Title/Name, designation, material, dimension etc	Article No./Reference		
Designed by A.Matre	Checked by PC	Approved by - date OIN	File name XXX	Date 2008.11.04	Scale
<p style="text-align: center;">SKIPPER Electronics AS</p> <p style="text-align: center;">Electronic Unit Connection diagram</p>			Revision 00	Draw. edition 120430	Sheet 02
			<p style="text-align: center;">JB60</p>		

4) JB60CD MOUNTING DIAGRAM

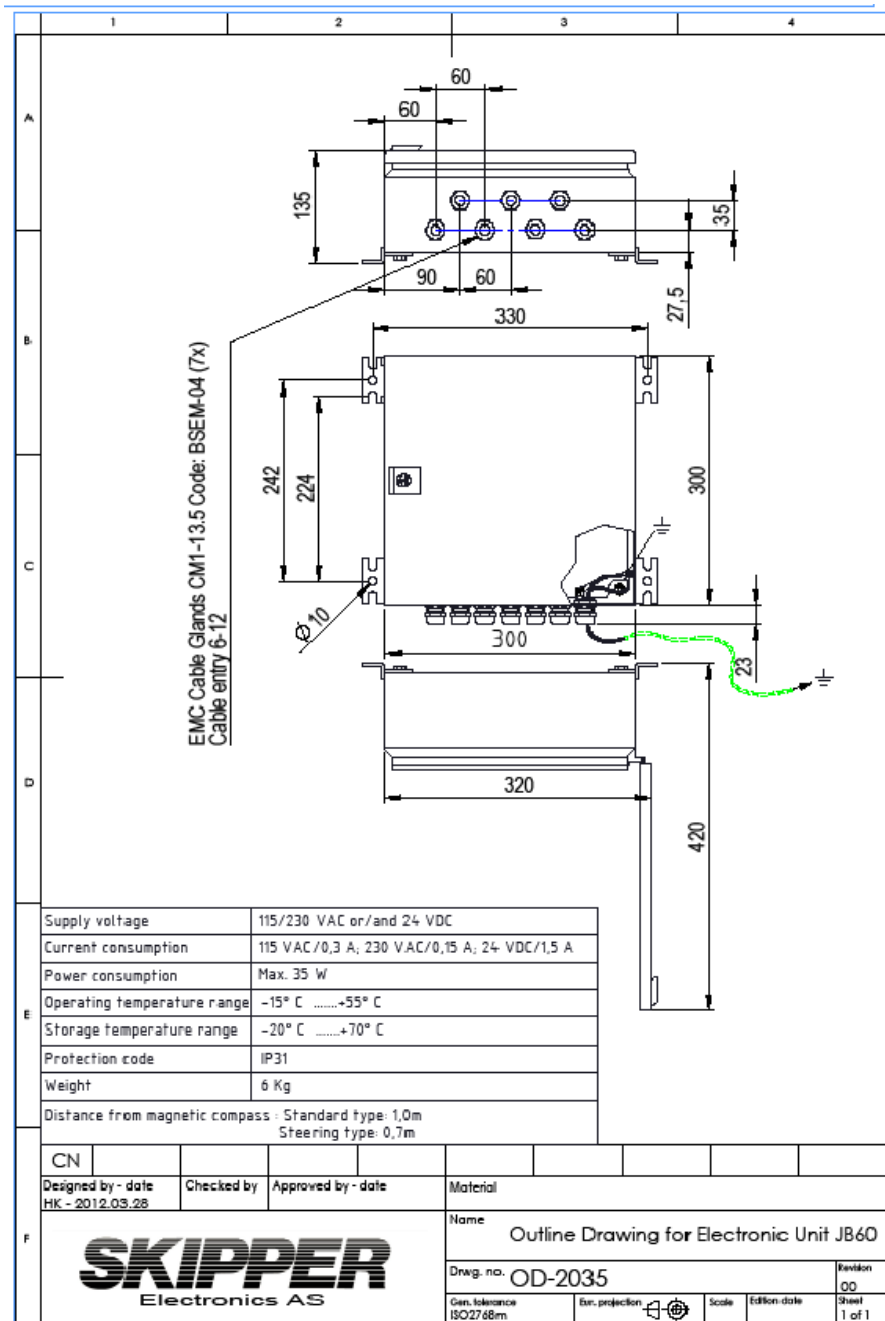

5) COMPACT DISPLAY MOUNTING DIAGRAM

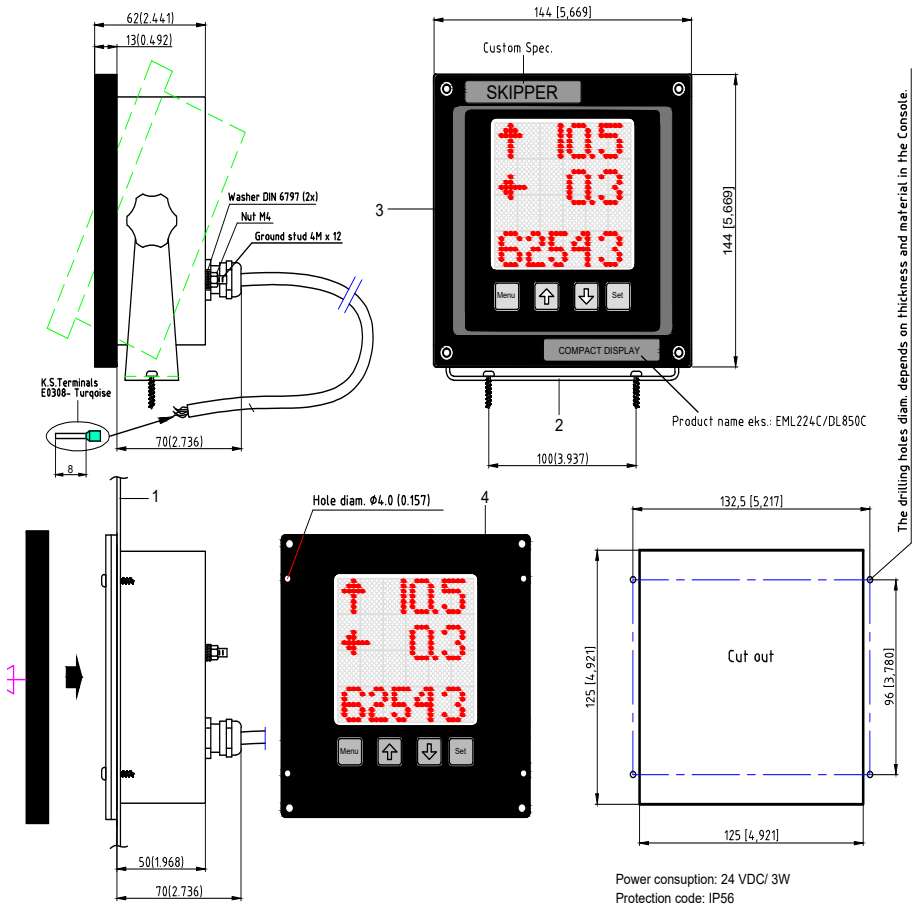

Console mounting order:

- A. Make a cut out in the Console (1) 125 x 125 (4.921 x 4.921)
- B. Remove the mounting bracket (2)
- C. Unscrew the 4 screws in the frame (3) (one in each corner) and remove the frame.
- D. Put the Monitor (4) in the cut out and mark the 4 centerpoints for the Drill in the Console (1) (The drilling holes diam. depends on thickness and material in the Console.)
- E. Use Panh. screws DIN 7981 Diam. 2.9 (0.114). Length depends on the Console thickness.
- F. Finally put on the frame (3). Make sure that the screwheads correspond with the cut outs in the frame.

6) COMPACT DISPLAY CONNECTION DIAGRAM

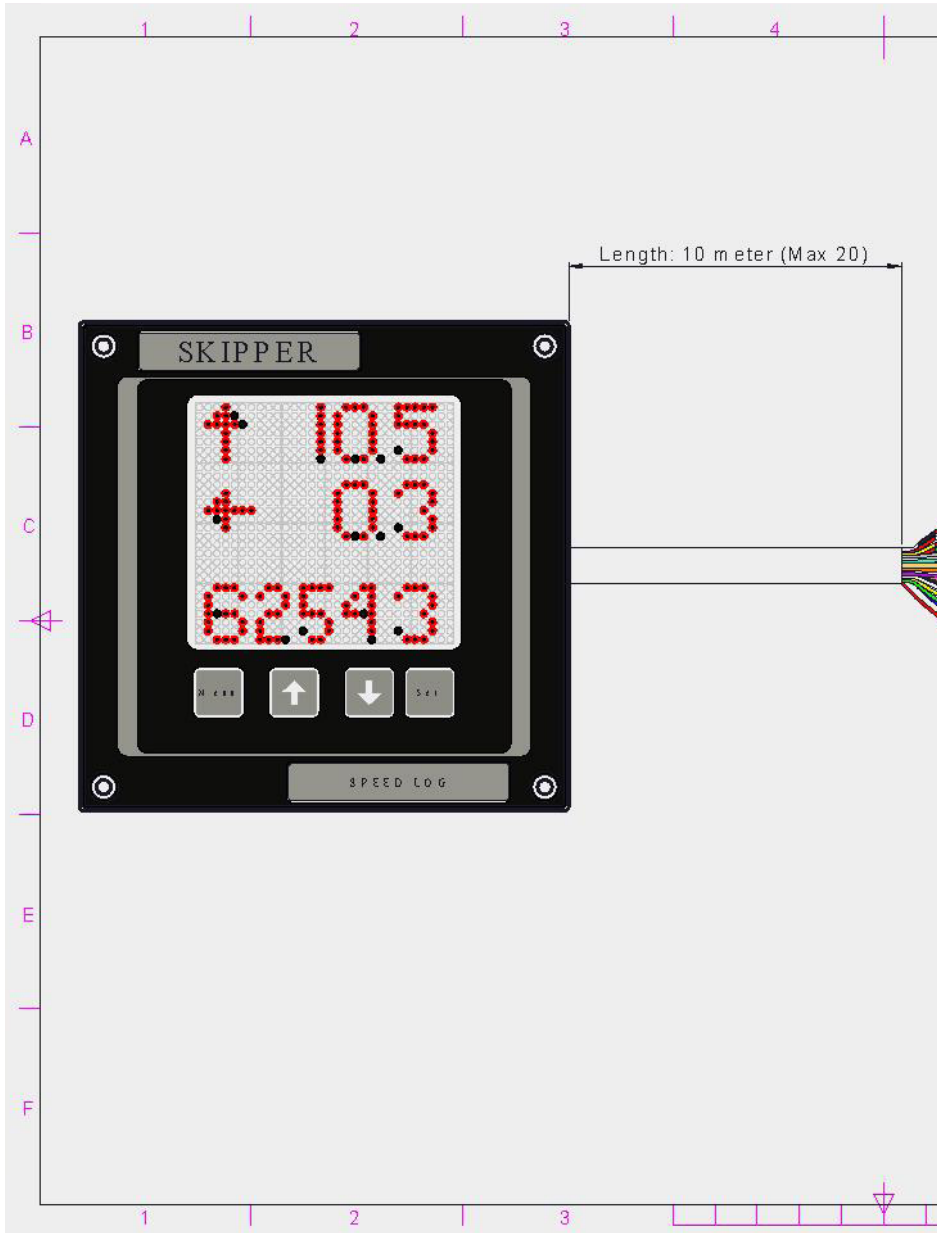

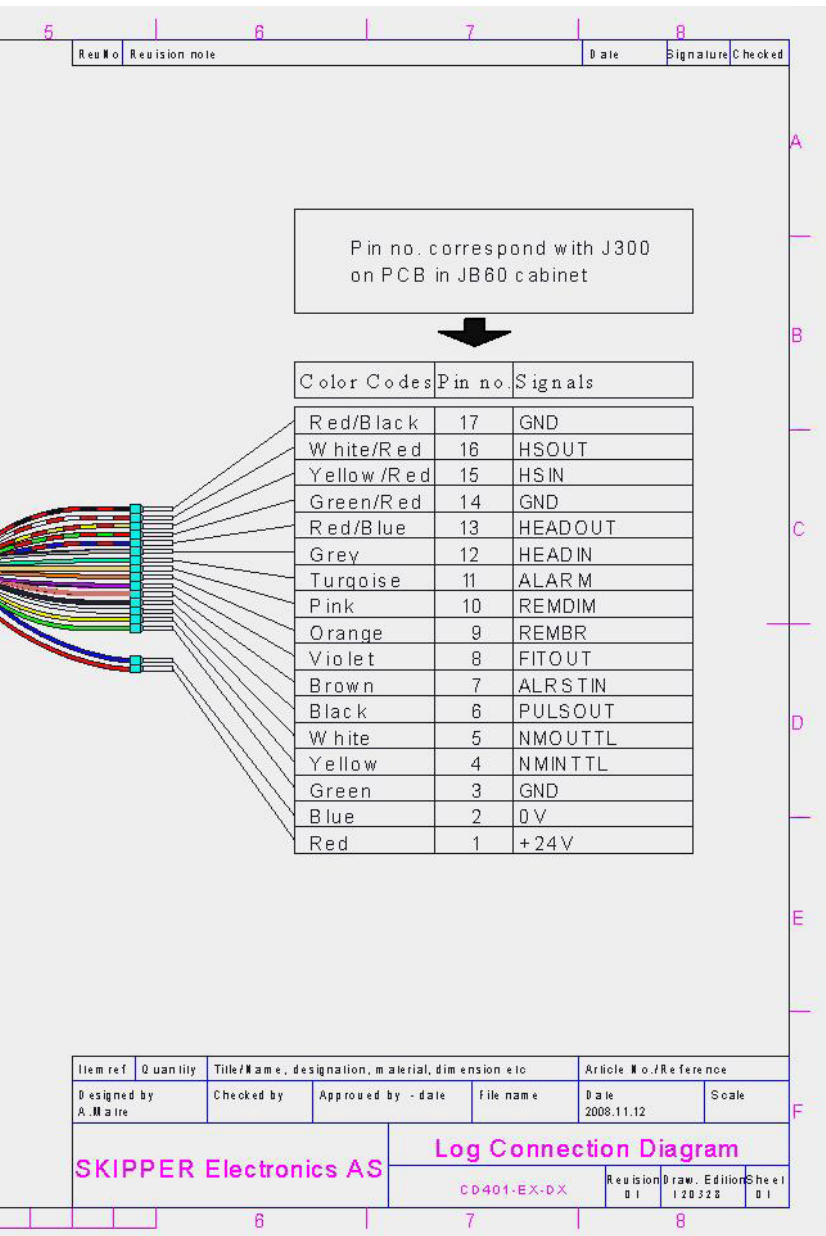

A

B

C

D

E

F

APPENDIX 3

OUTPUT FORMATS

PULSE OUTPUTS

There is one output channel with possibility for two galvanically separated output drivers. It is possible to set number of pulses per nautical mile (p/nm) for the optocoupled outputs.

- Number of pulses per nautical mile: 10, 100, 200 or 400.

NMEA OUTPUTS

EML 224 Compact Transmitted (Originated) NMEA 0183 (IEC61162-1) Messages

VBW	Multiple Speed Commands	EML: \$VMVBW,x.x,y,y,A,,, V,,V,,V*hh<CR><LF> DL1: \$VDVBW,x.x,,A,,, V,,V,,V*hh<CR><LF>	Where x.x is longitudinal speed in knots, y.y is transversal speed in knots in 2 axis systems.
VLW	Distance Travelled through the Water	EML: \$VMVLW,x.x,N,y,N,, N,,N*hh<CR><LF> DL1: \$VDVLW,x.x,N,y,N,, N,,N*hh<CR><LF>	x.x is daily trip, y.y is total trip in NM
MTW	Temperature	EML: \$VMMTW,x.x,C, *hh<CR><LF> DL1: \$VDMTW,x.x,C, *hh<CR><LF>	x.x is temperature in Celsius. All data fields are free format. Values will be presented with sign as needed (e.g "-" = astern, port)
VHW	Water speed and heading, relative	EML: \$VMVHW,,,x.x.N, x.x,K *hh<CR><lf> DL1: \$VDVHW,,,x.x.N, x.x,K *hh<CR><lf>	Resultant speed in knots and km/h.
XDR	Speed direction	EML: \$VMXDR,A,x.x,D, SPDD *hh<CR><LF> DL1: \$VDXDR,A,x.x,D, SPDD *hh<CR><LF>	The angular displacement (x.x) is set to 0 in forward direction and 180 in reverse direction.

*hh = Checksum

In addition, some propriety sentences are available. These can be obtained by turning on DIAG. (This disables all other NMEA outputs).

NMEA INPUTS

The following inputs are accepted

Dimming control	DDC	Remote dimming
GPS	ZTG, ZDA GGA	Time and date Time and position
Trip Reset	PSKPRSTT	Remote trip reset (from repeaters)

NMEA ALARM

This system has no requirement for alarms other than power failure. To simplify cabling and use of these previously available functions have been removed in this version. This ensures that IMO MSC302 is fulfilled. If these alarms are required the new generation Multi SKIPPER products fulfill all requirements

APPENDIX 4

SENDING THE SYSTEM FOR REPAIR

In the unlikely chance that a system fails, it may be necessary to send a part of the system back for repair. Make contact with your local dealer or SKIPPER for Returns Materials Authorisation number (RMA). (A list of service centres is available on www.skipper.no).

For normal service/support, please contact SKIPPER Electronics AS on e-mail: support@skipper.no, or contact our local dealer.

(List available on www.skipper.no).

APPENDIX 5

OTHER OPTIONS WITH THE COMPACT DISPLAY

COMPACT DISPLAY OPTIONS

The EML 224 Compact display can be used in the following modes:

Log Repeater Compact	CD401LR	A simple repeater for speed in 1 or 2 axis and trip. Limited functionality.
Multi Repeater Compact	CD401MR	A comprehensive repeater for many of the common NMEA messages. Also functions for user defined messages.
Multi Repeater Backwards	CD401MB	Same as CD401MR but all speeds are in opposite direction.
Single axis EML 124 Compact	CD401E1	With Electronic unit (JB60CD), sensor and cable.
Dual axis EML 224 Compact	CD401E2	With Electronic unit (JB60CD), sensor and cable.
EML 224 Compact Backwards	CD401EB	With Electronic unit (JB60CD), sensor and cables.
Single axis DL1 Doppler	CD401D1	With Electronic unit (JB60CD), sensor and cables.

The software for all these options are stored in the system and the options can be changed using a security code. This code can be obtained from sales@skipper.no or by sending an order to SKIPPER together with the systems serial number. (Obtained by opening the code screen in diagnostics). On entering the supplied code number, the system options will be set. However, please note that the cabling is different for the repeaters and the main Compact speed log systems, so these are not compatible without replacing the back plate.

CHANGING THE SYSTEM / ADDING OPTIONS

The Compact speed log is being developed as a low cost display alternative to full graphics displays. Most extra features are available for the EML 224 Compact and these can be activated using the CODE page in the setup menu. On this page, the systems unique ID is displayed. The new options can be purchased from the SKIPPER retailer to add extra functions. You will receive

an activation code and, if necessary, a software upgrade.

Entering the code on the CODE page will activate/deactivate the option.

NOTE: It is important to note that option codes are unique for each individual unit and will not work on other units.

INTERFACING WITH YOUR DISPLAY

It is possible to retrieve configuration and diagnostic data from the Compact. This can be performed by connecting to the electronic unit (JB60CD) 'compact' port, or directly through the NMEA port. In this way, error messages can be retrieved when required.

The SKIPPER Service software are available if required.

The following messages exists:

- \$PSKPVMPGTER,x if x = 0 = Last error, other = whole table
- \$PSKPVMPCEMO,mm,ll,tw,ta,lb,tb,ab,tmp,trip,total

where:

- mm = 0, auto.
- mm = 1, uses the following values: (see table)
- mm = 2, turn off.

Table showing mm = 1 values	
lw	longitudinal water value <xx.xx>
tw	transversal water value <xx.xx>
ta	aft transversal water value <xx.xx>
lb	longitudinal bottom value <xx.xx>
tb	transversal bottom value <xx.xx>
ab	aft transversal bottom value <xx.xx>
tmp	temperature <xx.xx>
trip	trip distance value <xxxx>
total	total distance value <xx.xx>

It may be necessary to remove other inputs on the same line (i.e remove power from the sensor).

ERROR MESSAGES

Symptom: Screen shows error instead of data.

Reason: If no data is received from the sensor, the screen will show 'ERROR'.

Fix: Check the LEDs are flashing in the Electronic unit. LD 100, LD 200.

- Connect a PC to the RS-232 Diagnostics Sensor/'HEAD' connector in the electronic unit. If the system is sending \$PSKP.....ERRBOR or similar, the voltage to the sensor is too low.
- Check if the Voltage on J200 p1 p2 is 18-25 V.
- Check if the voltage in junction box is >15 V, if not, twin pairs to get higher voltage. (If yellow/orange pair is not required and can be disconnected and used to parallel the power).
- If no, or garbled data, check that the pairs are connected correctly (A/B).

If you suspect you have a problem within the CD401 unit, an error message table can be retrieved from the unit by sending the message \$PSKPCPPCERROR <CR><LF> from the 'compact' connector of the JB60CD or the NMEA input on repeater. The returned format is in the form: ID, number of errors, last error, first 18 errors.

```
$ PSKPERRORTABLE,19,32,100,<Error18>,...,<Error1>
< Identifier >,<Number of errors(19)>,<Last Error after 18 errors(32)>,<first 18
error>,
```

This format shows a table of 20 numbers, where position 1 shows the number of errors stored. The errors are stored on the flash memory and will be retained. If you suspect an error, download the messages, then reset the error messages and try to perform the same error condition again. If successful, download the errors again and then check the list below. In addition, the self test values 0-4 can be used to check the main peripherals of the unit.

Error codes	Failure message	What it means	What to do
1	Can not open SPI	The internal communications are not giving the expected response	Restart
100	Can not open com 0 (NMEA)	Com port is having problems initialising	Restart Disconnect the inputs and restart, check baudrates
101	Com 0 NMEA failure	The port is busy	Restart Disconnect the inputs and restart, check baudrates
103	Com message too long	Check the input strings are correct	Restart
150-158	Self diagnostic errors	Self tests not working	Run through the individual self tests and find out which part is not working.
2	Sensor com failure	Com port is busy	Restart Disconnect the inputs and restart, check baudrates
200	Can not open com 1 (sensor)	Com port is having problems initialising	Restart Disconnect the inputs and restart, check baudrates
201	USART initialise failure com 1	The port is busy, restart.	Disconnect the inputs and restart, check baudrates
211	Can not transmit on Com 1	Com port is having problems initialising	
212, 252	Can not transmit on com 1		
3	Security can not save	Problem with security settings / options	

Error codes	Failure message	What it means	What to do
31	Security save failed	Could not save the new security settings	
32	Error table confirmation failed – port not replying	Can not save the error log. Flash memory failure	Check soldering on components on rear of the processor board in the CD401 unit.
4	Config retrieve failed	Could not read the last config settings, defaults will be used	Cal will be wrong
40	SSC lost coms	The Communication between the screen/ keyboard and processor is not performing correctly.	Buttons may not work, and the screen may not update. Check activity dot. Reboot. Check cables and circuit boards in CD401 unit.
41	DMA write overflow	Data coming too fast?	
42	Config confirmation failed	Could not write the new config – Probably flash memory problem	Try diagnostics test nr 1. Check soldering of flash chip on rear of processor board of CD401 unit.
5	Boot retrieve failed	Could not find the boot information – probably a memory failure	Restart.
52	Boot config confirmation failed		

Error codes	Failure message	What it means	What to do
6	Reply failure – no contact with EML	The EML is not responding	Check the connection is correct. Restart, check the options are correct
61	Bad communication with EML sensor	The CD401 has failed in an attempt to get a response from the EML 224S sensor	Check connections to the sensor, check the baudrates are the same.
All other messages	Some other codes exist, however will not assist in diagnostics.	If you have a problem – contact SKIPPER development (development@skipper.no)	

APPENDIX 6

SUPPORT SOFTWARE

THE SKIPPER SERVICE SOFTWARE

SKIPPER has developed support software allowing the user to use a single package to maintain the system. The software can be downloaded from the SKIPPER website www.skipper.no. When opening the software, the user should select the correct hardware, and then follow the instructions.

The sensor and display firmware can be upgraded using this software.

Connect a PC com port (RS-232) to the Head Compact 9 pin D-type connector in the electronic unit, and select CD401 in the software or connect to the sensor connector and select the EML 224 / DL1 sensor.

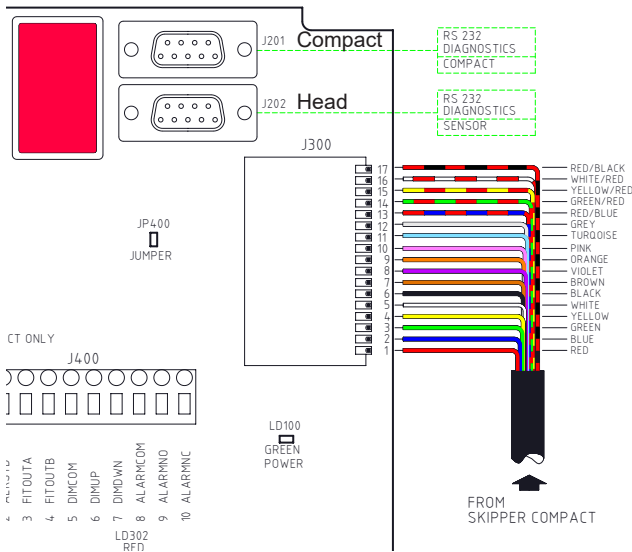

INSTALLATION/COMMISIONING OF THE COMPACT SPEED LOG

Boat/Build Name		Date:				Bridge Manufacturer:				
Equipment Summary:										
Display:	CD401 -	E1	E2	LR	MR	EB	MB	D1	Serial No:	
Electronic Unit	JB60 -	CD		N2		Serial No.:				
Cable type:		Length:								
Sensor:	EML 224	DL1	Sea valve	Tank		Serial No.:				
Bottom part:	Tank	Valve				Serial No.:				
Equipment Details:										
Bottom part:	Bolts checked		Alignment correct			Sensor fully inserted				
Electronic unit:	Mounted where?				NMEA out going to?					
	PULSE connected to?				NMEA IN connected to?					
	Power connected		24 V	115 V	230 V					
Alarms	System alarm to?		Relay (NO or NC)				Power Fitness alarm to?			
Display	Cable length?				NMEA Outputs		VBW	VLW	VHW	MTW
Calibration Data:										
Heading offset (CD401 E2 only)										
Point ____ (low speed)		Real:				Measured:				
Point ____ (high speed)		Real:				Measured:				
Point ____		Real:				Measured:				
Commisioned by:				Company:				Email:		

This page intentionally left blank

This page intentionally left blank

SKIPPER

SKIPPER Electronics AS
Enebakkeveien 150
P. O. Box 151, Manglerud
0612 Oslo, Norway
www.skipper.no

Telephone: +47 23 30 22 70
Telefax: +47 23 30 22 71
E-mail: support@skipper.no
Co. reg. no: NO-965378847-MVA